

US SFW GROUP MARINE BEARINGS

JULU COUNTY HONGWEI SEALING&ELECTRIC PARTS CO.,LTD

yjm Naval Brass Sleeve Bearings

yjm Naval Brass Sleeve Bearings adapt equally well to strut and stern tube mounts, and often used effectively as rudder-stock and pintle bushings. Bearing diameters are precision fitted to designated shaft size with the correct clearance for efficient water lubrication. External brass shells are machined and polished to provide easy fitting.

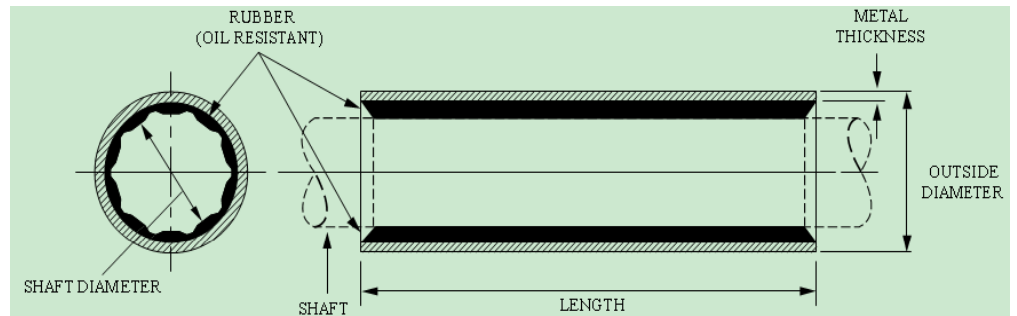
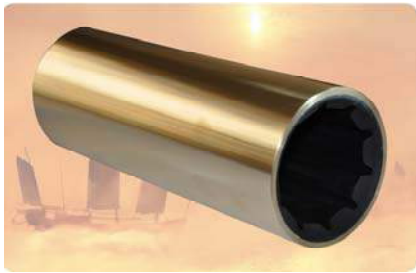

INCH SIZE SERIE

YJM Part Number	Shaft Diameter Dimensions		Outside Diameter Dimensions		Length Dimensions		Metal Thickness Dimensions		Weight		Price
	inches	mm	inches	mm	inches	mm	inches	mm	lb.	kg.	(USD) FOB TIANJIN
yjm BSIN001	3/4	19.050	1 1/4	31.750	3	76.20		2.00	1.74	0.79	11.528
yjm BSIN002	7/8	22.225	1 1/4	31.750	3 1/2	88.90		1.59	1.89	0.85	11.930
yjm BSIN003	7/8	22.225	1 3/8	34.925	3 1/2	88.90		2.00	2.18	0.99	12.982
yjm BSIN004	7/8	22.225	1 1/2	38.100	3 1/2	88.90		2.00	2.43	1.10	13.529
yjm BSIN005	7/8	22.225	1 1/2	38.100	3 1/2	88.90		2.00	2.43	1.10	13.529
yjm BSIN006	7/8	22.225	1 1/2	38.100	3 1/2	88.90	1/8	3.18	2.60	1.18	14.691
yjm BSIN007	1	25.400	1 1/4	31.750	4	101.60		1.19	2.01	0.91	14.035
yjm BSIN008	1	25.400	1 1/2	38.100	4	101.60		2.20	2.70	1.22	14.419
yjm BSIN009	1	25.400	1 5/8	41.275	4	101.60		2.20	2.98	1.35	16.958
yjm BSIN010	1	25.400	2	50.800	4	101.60		2.20	3.88	1.76	19.814
yjm BSIN011	1	25.400	2	50.800	4	101.60	1/8	3.18	4.12	1.87	21.367
yjm BSIN012	1	25.400	1 1/2	38.100	4	101.60	1/8	3.18	2.85	1.29	15.513
yjm BSIN013	1	25.400	1 3/8	34.930	4	101.60	1/16	1.59	2.32	1.05	12.916
yjm BSIN014	1	25.400	1 5/8	41.280	4	101.60		2.20	2.98	1.35	16.959
yjm BSIN015	1	25.400	1 5/8	41.280	4	101.60	1/8	3.18	3.16	1.43	18.169
yjm BSIN016	1 1/8	28.575	1 1/2	38.100	4 1/2	114.30		2.20	2.92	1.32	15.040
yjm BSIN017	1 1/8	28.575	1 5/8	41.275	4 1/2	114.30		2.20	3.24	1.47	17.675
yjm BSIN018	1 1/8	28.575	1 3/4	44.450	4 1/2	114.30		2.20	3.56	1.61	18.680
yjm BSIN019	1 1/8	28.575	2	50.800	4 1/2	114.30		2.20	4.23	1.92	20.835
yjm BSIN020	1 1/8	28.575	2	50.800	4 1/2	114.30		2.20	4.23	1.92	20.834
yjm BSIN021	1 1/8	28.575	2	50.800	4 1/2	114.30	1/8	3.18	4.49	2.03	22.574
yjm BSIN022	1 1/8	28.575	1 1/2	38.100	4 1/2	114.30	1/16	1.59	2.80	1.27	15.893
yjm BSIN023	1 1/8	28.575	1 3/4	44.450	4 1/2	114.30		2.20	3.56	1.61	18.679
yjm BSIN024	1 1/8	28.575	1 3/4	44.450	4 1/2	114.30	1/8	3.18	3.78	1.71	20.163
yjm BSIN025	1 1/8	28.575	1 5/8	41.280	4 1/2	114.30		2.20	3.24	1.47	17.676
yjm BSIN026	1 1/8	28.575	1 5/8	41.280	4 1/2	114.30	1/8	3.18	3.43	1.56	19.031
yjm BSIN027	1 1/4	31.750	1 1/2	38.100	5	127.00		1.70	3.02	1.37	14.863

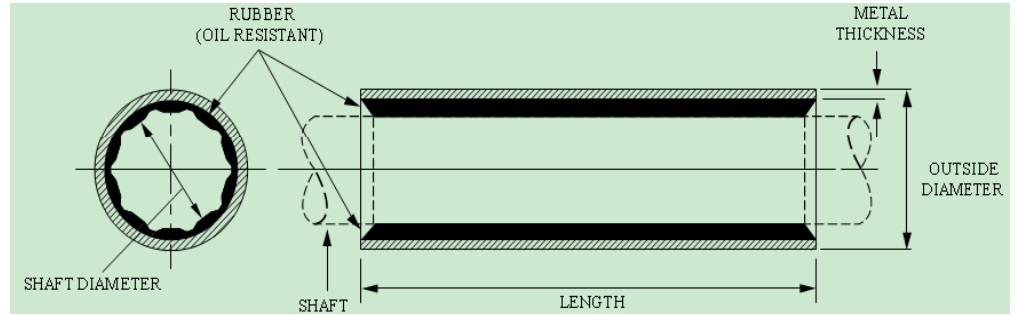

INCH SIZE SERIE

YJM Part Number	Shaft Diameter Dimensions		Outside Diameter Dimensions		Length Dimensions		Metal Thickness Dimensions		Weight		Price
	inches	mm	inches	mm	inches	mm	inches	mm	lb.	kg.	(USD) FOB TIANJIN
yjm BSIN028	1 1/4	31.750	1 5/8	41.275	5	127.00		2.20	3.47	1.57	18.321
yjm BSIN029	1 1/4	31.750	1 5/8	41.275	5	127.00	1/8	3.18	3.69	1.67	19.822
yjm BSIN030	1 1/4	31.750	1 3/4	44.450	5	127.00		2.20	3.83	1.73	19.424
yjm BSIN031	1 1/4	31.750	2	50.800	5	127.00		2.20	4.56	2.07	21.783
yjm BSIN032	1 1/4	31.750	2	50.800	5	127.00	1/8	3.18	4.84	2.20	23.710
yjm BSIN033	1 1/4	31.750	2 1/8	53.975	5	127.00		2.20	4.94	2.24	22.973
yjm BSIN034	1 1/4	31.750	1 1/2	38.100	5	127.00	1/16	1.59	3.00	1.36	16.357
yjm BSIN035	1 1/4	31.750	1 3/4	44.450	5	127.00	1/8	3.18	4.07	1.84	21.067
yjm BSIN036	1 1/4	31.750	2 1/8	53.980	5	127.00		2.20	4.94	2.24	22.975
yjm BSIN037	1 1/4	31.750	2 1/8	53.980	5	127.00	1/8	3.18	5.25	2.38	25.044
yjm BSIN038	1 3/8	34.925	1 7/8	47.625	5 1/2	139.70		2.20	4.47	2.02	21.322
yjm BSIN039	1 3/8	34.925	2	50.800	5 1/2	139.70		2.20	4.87	2.21	22.653
yjm BSIN040	1 3/8	34.930	2	50.800	5 1/2	139.70		2.20	4.87	2.21	22.652
yjm BSIN041	1 3/8	34.930	2	50.800	5 1/2	139.70	1/8	3.18	5.18	2.35	24.766
yjm BSIN042	1 3/8	34.925	2 1/8	53.975	5 1/2	139.70		2.20	5.28	2.39	23.949
yjm BSIN043	1 3/8	34.925	2 3/8	60.325	5 1/2	139.70		2.20	6.12	2.77	25.854
yjm BSIN044	1 3/8	34.930	1 7/8	47.630	5 1/2	139.70		2.20	4.47	2.02	21.324
yjm BSIN045	1 3/8	34.930	1 7/8	47.630	5 1/2	139.70	1/8	3.18	4.75	2.15	23.282
yjm BSIN046	1 3/8	34.930	2 1/8	53.980	5 1/2	139.70		2.20	5.28	2.39	23.951
yjm BSIN047	1 3/8	34.930	2 1/8	53.980	5 1/2	139.70	1/8	3.18	5.61	2.54	26.220
yjm BSIN048	1 3/8	34.930	2 3/8	60.330	5 1/2	139.70		2.20	6.12	2.77	25.855
yjm BSIN049	1 3/8	34.930	2 3/8	60.330	5 1/2	139.70	1/8	3.18	6.51	2.95	28.294
yjm BSIN050	1 1/2	38.100	2	50.800	6	152.40		2.50	5.26	2.38	24.152
yjm BSIN051	1 1/2	38.100	2	50.800	6	152.40		2.60	5.29	2.40	24.388
yjm BSIN052	1 1/2	38.100	2	50.800	6	152.40	1/8	3.18	5.49	2.49	25.737
yjm BSIN053	1 1/2	38.100	2	50.800	8	203.20		2.50	6.81	3.09	28.964
yjm BSIN054	1 1/2	38.100	2 1/4	57.150	6	152.40		2.50	6.17	2.80	26.233
yjm BSIN055	1 1/2	38.100	2 1/4	57.150	6.00	152.40		2.50	6.17	2.80	28.678
yjm BSIN056	1 1/2	38.100	2 1/4	57.150	6.00	152.40	1/8	3.18	6.44	2.92	27.954
yjm BSIN057	1 1/2	38.100	2 3/8	60.325	6	152.40		2.50	6.64	3.01	27.658
yjm BSIN058	1 1/2	38.100	2 3/8	60.330	6	152.40		2.50	6.64	3.01	27.660
yjm BSIN059	1 1/2	38.100	2 3/8	60.330	6	152.40	1/8	3.18	6.93	3.14	29.492
yjm BSIN060	1 5/8	41.275	2 1/8	53.975	6 1/2	165.10		2.50	6.01	2.73	26.463
yjm BSIN061	1 5/8	41.275	2 5/8	66.675	6 1/2	165.10		2.50	8.04	3.65	35.102
yjm BSIN062	1 5/8	41.280	2 1/8	53.980	6 1/2	165.10	1/8	2.50	6.02	2.73	26.465
yjm BSIN063	1 5/8	41.280	2 1/8	53.980	6 1/2	165.10	1/8	3.18	6.28	2.85	28.306
yjm BSIN064	1 5/8	41.280	2 5/8	66.680	6 1/2	165.10	1/8	2.50	8.04	3.65	35.104
yjm BSIN065	1 5/8	41.280	2 5/8	66.680	6 1/2	165.10	1/8	3.18	8.39	3.80	37.325

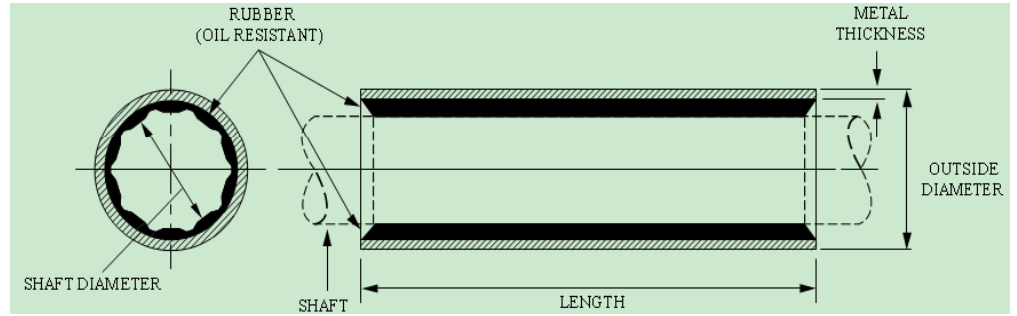
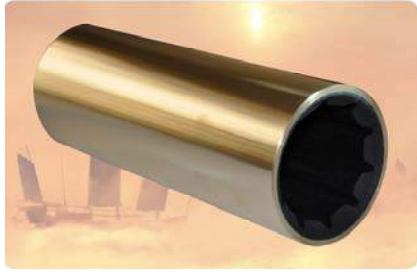

INCH SIZE SERIE

YJM Part Number	Shaft Diameter Dimensions		Outside Diameter Dimensions		Length Dimensions		Metal Thickness Dimensions		Weight		Price
	inches	mm	inches	mm	inches	mm	inches	mm	lb.	kg.	(USD) FOB TIANJIN
yjm BSIN066	1 3/4	44.450	2 1/4	57.150	7	177.80		2.50	6.82	3.09	27.823
yjm BSIN067	1 3/4	44.450	2 1/4	57.150	7	177.80	1/8	3.18	7.13	3.23	29.825
yjm BSIN068	1 3/4	44.450	2 3/8	60.325	7	177.80		2.50	7.36	3.33	29.464
yjm BSIN069	1 3/4	44.450	2 1/2	63.500	7	177.80		2.50	7.90	3.58	34.459
yjm BSIN070	1 3/4	44.450	2 1/2	63.500	7	177.80	1/8	3.18	8.26	3.74	36.718
yjm BSIN071	1 3/4	44.450	2 5/8	66.675	7	177.80		2.50	8.46	3.83	36.178
yjm BSIN072	1 3/4	44.450	2 5/8	66.675	7 1/2	190.50		2.50	9.00	4.08	37.747
yjm BSIN073	1 3/4	44.450	2 3/8	60.330	7	177.80	1/8	3.18	7.69	3.48	31.598
yjm BSIN074	1 3/4	44.450	2 5/8	66.680	7	177.80		2.50	8.46	3.83	36.214
yjm BSIN075	1 3/4	44.450	2 5/8	66.680	7	177.80	1/8	3.18	8.84	4.00	38.602
yjm BSIN076	1 7/8	47.625	2 5/8	66.675	7 1/2	190.50		2.50	8.85	4.01	37.145
yjm BSIN077	1 7/8	47.625	2 15/16	74.613	7 1/2	190.50		2.50	10.38	4.70	43.864
yjm BSIN078	1 7/8	47.625	2 15/16	74.613	8	203.20		2.50	11.00	4.99	45.689
yjm BSIN079	1 7/8	47.630	2 15/16	74.610	7 1/2	190.50	3/32	2.38	10.30	4.67	43.078
yjm BSIN080	1 7/8	47.630	2 15/16	74.610	7 1/2	190.50	3/32	2.50	10.38	4.70	43.596
yjm BSIN081	1 7/8	47.630	2 5/8	66.680	7 1/2	190.50		2.50	8.85	4.01	37.181
yjm BSIN082	1 7/8	47.630	2 5/8	66.680	7 1/2	190.50	1/8	3.18	9.25	4.19	39.736
yjm BSIN083	2	50.800	2 1/2	63.500	8	203.20		2.50	8.58	3.89	36.050
yjm BSIN084	2	50.800	2 5/8	66.675	8	203.20		2.50	9.21	4.17	37.996
yjm BSIN085	2	50.800	2 3/4	69.850	8	203.20		2.50	9.85	4.46	40.019
yjm BSIN086	2	50.800	2 3/4	69.850	8	203.20		2.75	10.37	4.70	42.667
yjm BSIN087	2	50.800	3	76.200	8	203.20		2.50	11.16	5.06	43.117
yjm BSIN088	2	50.800	3	76.200	8	203.20		2.75	11.25	5.10	43.833
yjm BSIN089	2	50.800	3	76.200	8	203.20	1/8	3.18	11.66	5.28	46.078
yjm BSIN090	2	50.800	2 3/4	69.850	8	203.20		2.60	9.92	4.49	40.445
yjm BSIN091	2	50.800	2 3/4	69.850	8	203.20	1/8	3.18	10.30	4.67	42.888
yjm BSIN092	2	50.800	2 5/8	66.680	8	203.20		2.50	9.21	4.17	38.032
yjm BSIN093	2	50.800	2 5/8	66.680	8	203.20	1/8	3.18	9.63	4.37	40.755
yjm BSIN094	2 1/8	53.975	2 3/4	69.850	8 1/2	215.90		2.50	10.21	4.63	40.861
yjm BSIN095	2 1/8	53.975	2 15/16	74.613	8 1/2	215.90		2.50	11.25	5.10	45.627
yjm BSIN096	2 1/8	53.975	3	76.200	8 1/2	215.90		2.50	11.60	5.26	44.031
yjm BSIN097	2 1/8	53.980	3	76.200	8 1/2	215.90		2.50	11.60	5.26	43.976
yjm BSIN098	2 1/8	53.980	3	76.200	8 1/2	215.90	1/8	3.18	12.13	5.50	46.674
yjm BSIN099	2 1/8	53.975	3 1/8	79.375	8 1/2	215.90		2.50	12.31	5.58	48.039
yjm BSIN100	2 1/8	53.980	2 15/16	74.610	8 1/2	215.90		2.50	11.25	5.10	45.760
yjm BSIN101	2 1/8	53.980	2 15/16	74.610	8 1/2	215.90	1/8	3.18	11.76	5.33	49.304
yjm BSIN102	2 1/8	53.980	2 3/4	69.850	8 1/2	215.90		2.50	10.21	4.63	40.860
yjm BSIN103	2 1/8	53.980	2 3/4	69.850	8 1/2	215.90	1/8	3.18	10.69	4.84	43.906

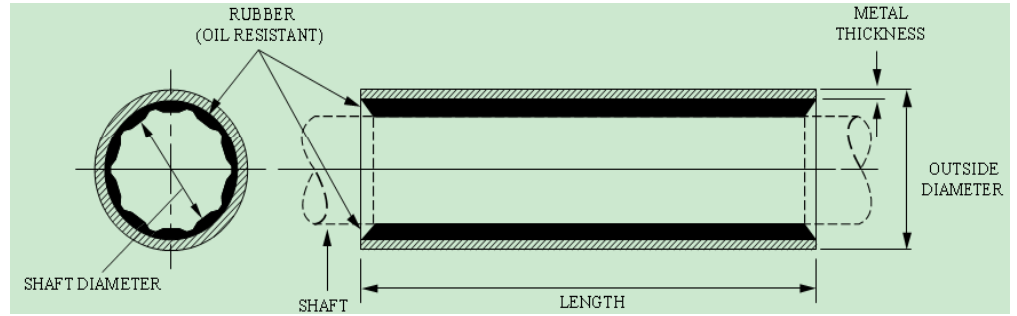

INCH SIZE SERIE

YJM Part Number	Shaft Diameter Dimensions		Outside Diameter Dimensions		Length Dimensions		Metal Thickness Dimensions		Weight		Price
	inches	mm	inches	mm	inches	mm	inches	mm	lb.	kg.	(USD) FOB TIANJIN
yjm BSIN104	2 1/8	53.980	3 1/8	79.380	8 1/2	215.90		2.50	12.31	5.58	48.039
yjm BSIN105	2 1/8	53.980	3 1/8	79.380	8 1/2	215.90	1/8	3.18	12.86	5.83	49.350
yjm BSIN106	2 1/4	57.150	2 1/2	63.500	9	228.60		2.60	9.20	4.17	39.298
yjm BSIN107	2 1/4	57.150	3	76.200	9	228.60		2.60	11.72	5.31	47.005
yjm BSIN108	2 1/4	57.150	3	76.200	9	228.60		2.60	12.09	5.48	44.771
yjm BSIN109	2 1/4	57.150	3	76.200	9	228.60		2.90	12.33	5.59	46.491
yjm BSIN110	2 1/4	57.150	3	76.200	9	228.60	1/8	3.18	12.56	5.69	47.619
yjm BSIN111	2 1/4	57.150	3 1/8	79.375	9	228.60		2.60	12.84	5.82	49.538
yjm BSIN112	2 1/4	57.150	3 1/8	79.380	9	228.60		2.60	12.84	5.82	47.368
yjm BSIN113	2 1/4	57.150	3 1/8	79.380	9	228.60	1/8	3.18	13.34	6.04	50.000
yjm BSIN114	2 1/4	57.150	3 1/4	82.550	9	228.60		2.60	13.61	6.17	54.480
yjm BSIN115	2 1/4	57.150	3 1/4	82.550	9	228.60		2.90	13.88	6.29	56.491
yjm BSIN116	2 1/4	57.150	3 1/4	82.550	9	228.60	1/8	3.18	14.13	6.40	57.895
yjm BSIN117	2 1/4	57.150	3 3/8	85.725	9	228.60		2.60	14.39	6.52	56.798
yjm BSIN118	2 1/4	57.150	3 3/8	85.730	9	228.60		2.60	14.39	6.52	56.799
yjm BSIN119	2 1/4	57.150	3 3/8	85.730	9	228.60	1/8	3.18	14.93	6.77	60.027
yjm BSIN120	2 1/4	57.150	3 15/16	100.013	9	228.60		2.60	18.05	8.18	69.298
yjm BSIN121	2 1/4	57.150	2 15/16	74.610	9	228.60	3/32	2.60	11.71	5.31	47.430
yjm BSIN122	2 3/8	60.325	3	76.200	9 1/2	241.30		2.60	12.46	5.65	45.980
yjm BSIN123	2 3/8	60.330	3	76.200	9 1/2	241.30		2.60	12.46	5.65	46.229
yjm BSIN124	2 3/8	60.330	3	76.200		241.30	1/8	3.18	12.96	5.87	49.264
yjm BSIN125	2 3/8	60.325	3 1/8	79.375	9 1/2	241.30		2.60	13.25	6.01	50.299
yjm BSIN126	2 3/8	60.330	3 1/8	79.380	9 1/2	241.30		2.60	13.25	6.01	50.124
yjm BSIN127	2 3/8	60.330	3 1/8	79.380	9 1/2	241.30	1/8	3.18	13.78	6.24	52.995
yjm BSIN128	2 3/8	60.325	3 1/4	82.550	9 1/2	241.30		2.60	14.06	6.37	55.418
yjm BSIN129	2 3/8	60.330	3 1/4	82.550	9 1/2	241.30		2.60	14.06	6.37	55.418
yjm BSIN130	2 3/8	60.330	3 1/4	82.550	9 1/2	241.30	1/8	3.18	14.60	6.62	58.650
yjm BSIN131	2 3/8	60.325	3 3/8	85.725	9 1/2	241.30		2.60	14.88	6.74	57.914
yjm BSIN132	2 3/8	60.330	3 3/8	85.730	9 1/2	241.30		2.60	14.88	6.74	57.914
yjm BSIN133	2 3/8	60.330	3 3/8	85.730	9 1/2	241.30	1/8	3.18	15.45	7.00	61.331
yjm BSIN134	2 1/2	63.500	3	76.200	10	254.00		2.80	12.98	5.88	47.602
yjm BSIN135	2 1/2	63.500	3	76.200	10	254.00	1/8	3.18	13.32	6.04	50.035
yjm BSIN136	2 1/2	63.500	3 1/8	79.375	10	254.00		2.80	13.82	6.26	52.024
yjm BSIN137	2 1/2	63.500	3 1/8	79.380	10	254.00		2.80	13.82	6.26	52.024
yjm BSIN138	2 1/2	63.500	3 1/8	79.380	10	254.00	1/8	3.18	14.18	6.42	53.944
yjm BSIN139	2 1/2	63.500	3 1/4	82.550	10	254.00		2.80	14.67	6.65	57.325
yjm BSIN140	2 1/2	63.500	3 1/4	82.550	10	254.00		3.00	14.87	6.74	57.325
yjm BSIN141	2 1/2	63.500	3 1/4	82.550	10	254.00	1/8	3.18	15.05	6.82	59.251

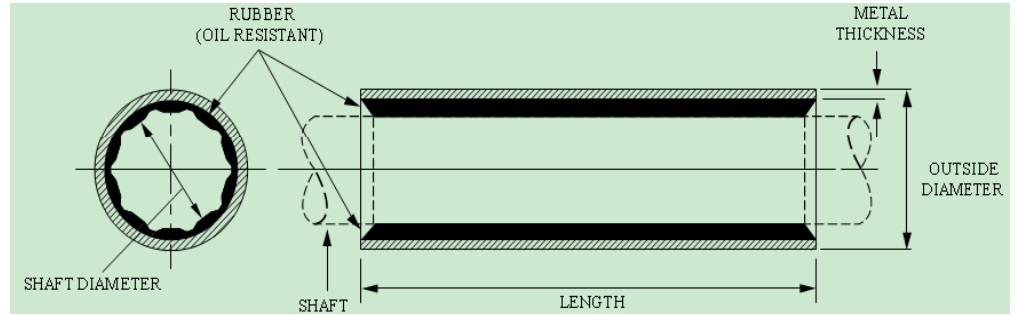

INCH SIZE SERIE

YJM Part Number	Shaft Diameter Dimensions		Outside Diameter Dimensions		Length Dimensions		Metal Thickness Dimensions		Weight		Price
	inches	mm	inches	mm	inches	mm	inches	mm	lb.	kg.	(USD) FOB TIANJIN
yjm BSIN142	2 1/2	63.500	3 3/8	85.725	10	254.00		2.80	15.54	7.04	60.002
yjm BSIN143	2 1/2	63.500	3 3/8	85.730	10	254.00		2.80	15.54	7.04	60.002
yjm BSIN144	2 1/2	63.500	3 3/8	85.730	10	254.00	1/8	3.18	15.93	7.22	62.286
yjm BSIN145	2 1/2	63.500	3 1/2	88.900	10	254.00		2.80	16.42	7.44	62.679
yjm BSIN146	2 1/2	63.500	3 1/2	88.900	10	254.00		3.20	16.85	7.64	64.035
yjm BSIN147	2 1/2	63.500	3 1/2	88.900	10	254.00	5/32	3.97	17.66	8.01	67.640
yjm BSIN148	2 5/8	66.675	3 1/8	79.375	10 1/2	266.70		2.80	14.16	6.42	52.614
yjm BSIN149	2 5/8	66.675	3 3/8	85.725	10 1/2	266.70		2.80	15.96	7.23	60.773
yjm BSIN150	2 5/8	66.680	3 3/8	85.730	10 1/2	266.70		2.80	15.96	7.24	60.773
yjm BSIN151	2 5/8	66.680	3 3/8	85.730	10 1/2	266.70	1/8	3.18	16.37	7.42	63.241
yjm BSIN152	2 5/8	66.675	3 1/2	88.900	10 1/2	266.70		2.80	16.89	7.65	63.628
yjm BSIN153	2 5/8	66.680	3 1/2	88.900	10 1/2	266.70		2.80	16.89	7.65	62.753
yjm BSIN154	2 5/8	66.680	3 1/2	88.900	10 1/2	266.70	1/8	3.18	17.31	7.85	63.830
yjm BSIN155	2 3/4	69.850	3 3/8	85.725	11	279.40		2.50	16.01	7.25	59.282
yjm BSIN156	2 3/4	69.850	3 3/8	85.730	11	279.40		2.50	16.01	7.25	59.282
yjm BSIN157	2 3/4	69.850	3 3/8	85.725	11	279.40		2.80	16.35	7.41	61.404
yjm BSIN158	2 3/4	69.850	3 3/8	85.730	11	279.40	1/8	3.18	16.77	7.60	63.509
yjm BSIN159	2 3/4	69.850	3 1/2	88.900	11	279.40		2.60	17.07	7.74	62.889
yjm BSIN160	2 3/4	69.850	3 1/2	88.900	11	279.40		3.00	17.54	7.95	67.544
yjm BSIN161	2 3/4	69.850	3 1/2	88.900	11	279.40	5/32	3.97	18.67	8.46	72.218
yjm BSIN162	2 3/4	69.850	3 3/4	95.250	11	279.40		2.60	19.03	8.62	68.946
yjm BSIN163	2 3/4	69.850	3 3/4	95.250	11	279.40		3.00	19.54	8.85	71.930
yjm BSIN164	2 3/4	69.850	3 3/4	95.250	11	279.40	1/8	3.18	19.76	8.96	73.318
yjm BSIN165	2 7/8	73.025	3 1/2	88.900	11 1/2	292.10		2.80	17.69	8.02	64.999
yjm BSIN166	2 7/8	73.030	3 1/2	88.900	11 1/2	292.10		2.80	17.69	8.02	76.890
yjm BSIN167	2 7/8	73.030	3 3/4	95.250	11 1/2	292.10		2.80	19.74	8.95	71.769
yjm BSIN168	2 7/8	73.030	3 3/4	95.250	11 1/2	292.10	1/8	3.18	20.25	9.18	75.506
yjm BSIN169	3	76.200	3 1/2	88.900	12	304.80		3.00	18.28	8.28	66.944
yjm BSIN170	3	76.200	3 1/2	88.900	12	304.80	1/8	3.18	18.51	8.39	78.070
yjm BSIN171	3	76.200	3 3/4	95.250	12	304.80		3.00	20.44	9.26	73.904
yjm BSIN172	3	76.200	3 3/4	95.250	12	304.80	1/8	3.18	20.69	9.38	75.421
yjm BSIN173	3	76.200	4	101.600	12	304.80		3.00	22.67	10.27	86.842
yjm BSIN174	3	76.200	4	101.600	12	304.80	1/8	3.18	22.93	10.39	89.474
yjm BSIN175	3	76.200	4	101.600	12	304.80		3.20	22.15	10.04	89.474
yjm BSIN176	3	76.200	4	101.600	12	304.80		3.50	22.20	10.06	89.474
yjm BSIN177	3	76.200	4	101.600	12	304.80		4.00	24.14	10.94	89.474
yjm BSIN178	3	76.200	4 1/8	104.775	12	304.80		3.00	23.80	10.79	91.228
yjm BSIN179	3	76.200	4 1/8	104.775	12	304.80		3.00	23.80	10.79	91.228

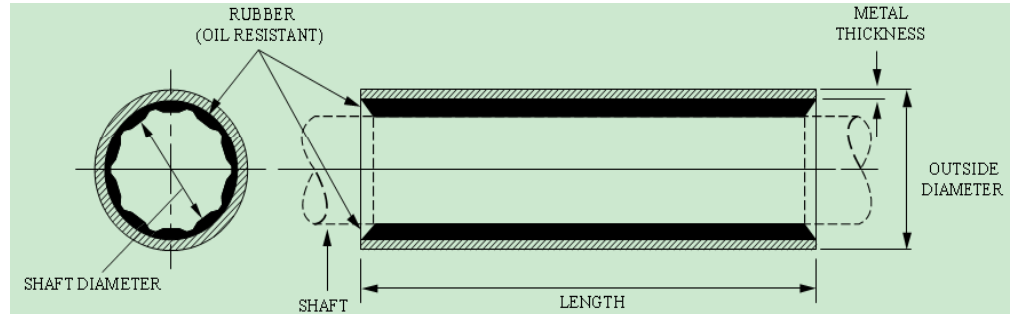
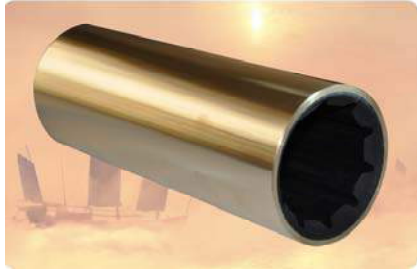

INCH SIZE SERIE

YJM Part Number	Shaft Diameter Dimensions		Outside Diameter Dimensions		Length Dimensions		Metal Thickness Dimensions		Weight		Price
	inches	mm	inches	mm	inches	mm	inches	mm	lb.	kg.	(USD) FOB TIANJIN
yjm BSIN180	3	76.200	4 1/8	104.775	12	304.80	1/8	3.18	24.08	10.91	92.807
yjm BSIN181	3	76.200	4 1/2	114.300	12	304.80		3.00	27.32	12.38	102.632
yjm BSIN182	3 1/8	79.375	4 1/4	107.950	12 1/2	317.50		2.80	25.19	11.41	99.123
yjm BSIN183	3 1/8	79.380	4 1/4	107.950	12 1/2	317.50		2.80	25.18	11.41	96.681
yjm BSIN184	3 1/8	79.375	4 1/4	107.950	12 1/2	317.50		3.00	25.52	11.56	0.000
yjm BSIN185	3 1/8	79.380	4 1/4	107.950	12 1/2	317.50	1/8	3.18	25.81	11.70	103.973
yjm BSIN186	3 1/4	82.550	4	101.600	13	330.20		2.70	23.07	10.46	85.965
yjm BSIN187	3 1/4	82.550	4	101.600	13	330.20	3mm	3.00	23.56	10.68	88.596
yjm BSIN188	3 1/4	82.550	4	101.600	13	330.20	1/8	3.18	23.84	10.81	90.351
yjm BSIN189	3 1/4	82.550	4 1/8	104.775	13	330.20		3.00	24.78	11.23	92.982
yjm BSIN190	3 1/4	82.550	4 1/8	104.775	13	330.20	1/8	3.18	25.08	11.37	94.737
yjm BSIN191	3 1/4	82.550	4 1/4	107.950	13	330.20		3.00	26.03	11.80	102.180
yjm BSIN192	3 1/4	82.550	4 1/4	107.950	13	330.20	1/8	3.18	26.33	11.94	105.823
yjm BSIN193	3 1/4	82.550	4 1/4	107.950	13	330.20		6.00	0.00		0.000
yjm BSIN194	3 1/4	82.550	4 1/2	114.300	13	330.20		3.00	28.57	12.95	111.075
yjm BSIN195	3 1/4	82.550	4 1/2	114.300	13	330.20	1/8	3.18	28.90	13.10	114.727
yjm BSIN196	3 1/4	82.550	4 1/2	114.300	15	381.00		3.00	32.71	14.83	123.725
yjm BSIN197	3 3/8	85.725	4 1/8	104.775	13 1/2	342.90		3.00	25.20	11.42	95.614
yjm BSIN198	3 3/8	85.730	4 1/2	114.300	13 1/2	342.90		3.00	29.12	13.20	111.177
yjm BSIN199	3 1/2	88.900	4 1/4	107.950	14	355.60		3.00	26.89	12.19	100.877
yjm BSIN200	3 1/2	88.900	4 1/4	107.950	14	355.60		3.00	26.89	12.19	103.247
yjm BSIN201	3 1/2	88.900	4 1/4	107.950	14	355.60	1/8	3.18	27.22	12.34	105.153
yjm BSIN202	3 1/2	88.900	4 1/2	114.300	14	355.60		3.00	29.62	13.42	112.154
yjm BSIN203	3 1/2	88.900	4 1/2	114.300	14	355.60	1/8	3.18	29.97	13.58	114.944
yjm BSIN204	3 1/2	88.900	4 1/2	114.300	14	355.60		3.50	30.59	13.87	117.544
yjm BSIN205	3 1/2	88.900	4 1/2	114.300	14	355.60		4.00	31.56	14.30	121.930
yjm BSIN206	3 1/2	90.000	4 1/2	114.300		360.00		4.00	31.74	14.39	125.362
yjm BSIN207	3 1/2	88.900	4 3/4	120.650	14	355.60	1/8	3.18	32.79	14.86	146.593
yjm BSIN208	3 1/2	88.900	4 3/4	120.650	14	355.60		3.60	33.66	15.26	0.000
yjm BSIN209	3 1/2	88.900	5	127.000	14	355.60		3.00	35.30	16.00	0.000
yjm BSIN210	3 5/8	92.075	4 1/4	107.950	14 1/2	368.30		3.00	27.24	12.35	100.721
yjm BSIN211	3 5/8	92.080	4 1/2	114.300	14 1/2	368.30		3.00	30.06	13.62	113.131
yjm BSIN212	3 5/8	92.080	4 1/2	114.300	14 1/2	368.30	1/8	3.18	30.42	13.79	115.402
yjm BSIN213	3 3/4	95.250	4 1/2	114.300	15	381.00		3.00	30.45	13.80	117.605
yjm BSIN214	3 3/4	95.250	4 1/2	114.300	15	381.00	1/8	3.18	30.82	13.97	120.406
yjm BSIN215	3 3/4	95.250	4 1/2	114.300	15	381.00		3.50	31.49	14.27	125.094
yjm BSIN216	3 3/4	95.250	4 3/4	120.650	15	381.00		3.00	33.44	15.15	148.381
yjm BSIN217	3 3/4	95.250	4 3/4	120.650	15	381.00	1/8	3.18	33.84	15.34	152.067

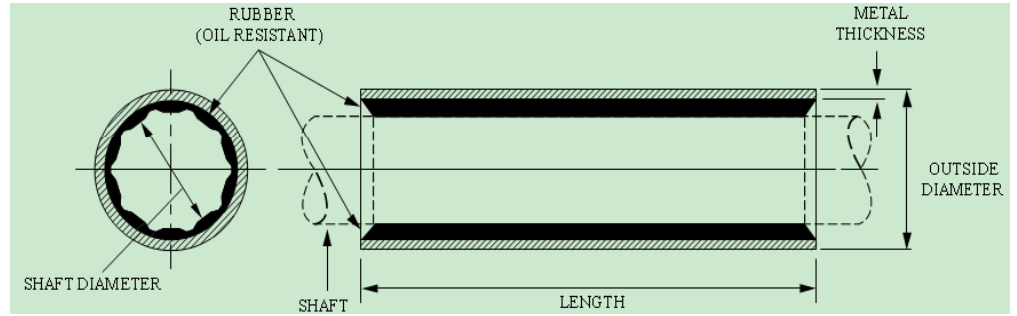
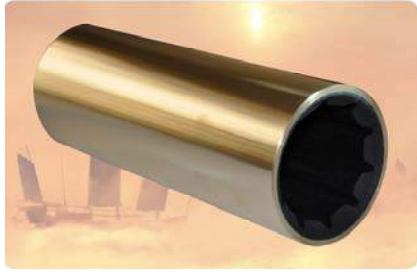

INCH SIZE SERIE

YJM Part Number	Shaft Diameter Dimensions		Outside Diameter Dimensions		Length Dimensions		Metal Thickness Dimensions		Weight		Price
	inches	mm	inches	mm	inches	mm	inches	mm	lb.	kg.	(USD) FOB TIANJIN
yjm BSIN218	3 3/4	95.250	5	127.000	15	381.00		3.00	36.51	16.55	159.649
yjm BSIN219	3 3/4	95.250	5	127.000	15	381.00		3.50	37.69	17.08	170.175
yjm BSIN220	3 3/4	95.250	5	127.000	15	381.00	3/16	4.76	40.60	18.40	188.080
yjm BSIN221	3 3/4	95.250	5 1/4	133.350	15	381.00		3.00	39.66	17.98	171.930
yjm BSIN222	3 3/4	95.250	5 1/4	133.350	15	381.00		3.50	40.90	18.54	182.538
yjm BSIN223	3 3/4	95.250	5 1/4	133.350	15	381.00	3/16	4.76	43.98	19.93	189.232
yjm BSIN224	3 7/8	98.425	5 1/4	133.350	15 1/2	393.70		3.50	41.56	18.84	180.928
yjm BSIN225	3 7/8	98.430	5 1/4	133.350	15 1/2	393.70		3.50	41.56	18.84	180.928
yjm BSIN226	3 7/8	98.430	5 1/4	133.350	15 1/2	393.70	3/16	4.76	44.74	20.28	203.409
yjm BSIN227	4	101.600	5	127.000	16	406.40		4.00	39.98	18.12	176.190
yjm BSIN228	4	101.600	5	127.000	16	406.40		4.25	40.59	18.40	180.702
yjm BSIN229	4	101.600	5	127.000	16	406.40	3/16	4.76	41.84	18.96	189.311
yjm BSIN230	4	101.600	5	127.000	16	406.40		5.00	42.42	19.22	194.737
yjm BSIN231	4	101.600	5	127.000	16	406.40		6.00	44.82	20.31	212.281
yjm BSIN232	4	101.600	5 1/4	133.350	16	406.40		4.00	43.47	19.70	190.428
yjm BSIN233	4	101.600	5 1/4	133.350	16	406.40		4.25	44.12	20.00	192.982
yjm BSIN234	4	101.600	5 1/4	133.350	16	406.40	3/16	4.76	45.44	20.59	201.754
yjm BSIN235	4	101.600	5 3/8	136.525	16	406.40	3/16	4.76	47.27	21.42	217.544
yjm BSIN236	4 1/8	104.780	5 1/4	133.350	16 1/2	419.10		4.00	44.04	19.96	185.965
yjm BSIN237	4 1/8	104.780	5 1/4	133.350	16 1/2	419.10	3/16	4.76	46.07	20.88	210.526
yjm BSIN238	4 1/4	107.950	5 1/4	133.350	16 1/2	419.10		4.00	43.30	19.62	192.982
yjm BSIN239	4 1/4	107.950	5 1/4	133.350	16 1/2	419.10		4.76	45.33	20.54	207.018
yjm BSIN240	4 1/4	107.950	5 1/4	133.350	17	431.80		4.00	44.55	20.19	196.491
yjm BSIN241	4 1/4	107.950	5 1/4	133.350	17	431.80		4.00	44.55	20.19	196.491
yjm BSIN242	4 1/4	107.950	5 1/2	139.700	17	431.80		4.00	48.35	21.91	215.789
yjm BSIN243	4 1/4	107.950	5 1/2	139.700	17	431.80	3/16	4.76	50.54	22.91	231.579
yjm BSIN244	4 3/8	111.130	5 1/2	139.700	17	431.80		4.00	47.56	21.55	208.772
yjm BSIN245	4 3/8	111.130	5 1/2	139.700	17	431.80		4.76	49.76	22.55	222.807
yjm BSIN246	4 3/8	111.125	5 1/2	139.700	17 1/2	444.50		4.00	48.90	22.16	215.789
yjm BSIN247	4 3/8	111.125	5 3/4	146.050	17 1/2	444.50		4.00	52.89	23.97	236.842
yjm BSIN248	4 3/8	111.130	5 3/4	146.050	17 1/2	444.50		4.00	52.89	23.97	236.842
yjm BSIN249	4 3/8	111.130	5 3/4	146.050	17 1/2	444.50	3/16	4.76	55.26	25.05	245.614
yjm BSIN250	4 1/2	114.300	5 1/2	139.700	18	457.20		4.00	49.38	22.38	219.298
yjm BSIN251	4 1/2	114.300	5 1/2	139.700	18	457.20		4.25	50.15	22.73	222.807
yjm BSIN252	4 1/2	114.300	5 1/2	139.700	18	457.20		4.40	50.60	22.93	226.316
yjm BSIN253	4 1/2	114.300	5 1/2	139.700	18	457.20	3/16	4.76	51.70	23.43	236.842
yjm BSIN254	4 1/2	114.300	5 5/8	142.880	18	457.20		4.00	51.42	23.30	219.298
yjm BSIN255	4 1/2	114.300	5 5/8	142.880	18	457.20		4.76	53.80	24.38	243.860

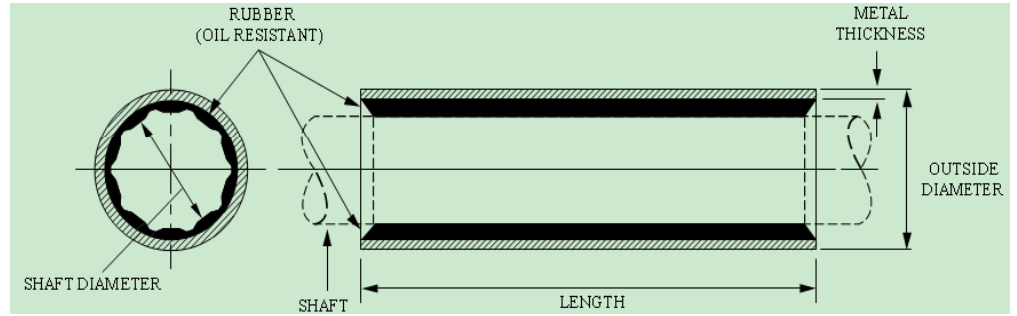
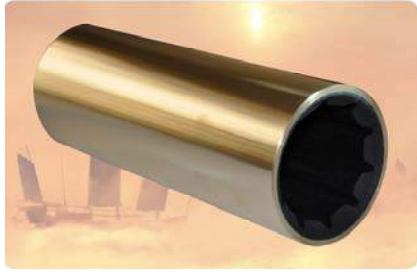

INCH SIZE SERIE

YJM Part Number	Shaft Diameter Dimensions		Outside Diameter Dimensions		Length Dimensions		Metal Thickness Dimensions		Weight		Price
	inches	mm	inches	mm	inches	mm	inches	mm	lb.	kg.	(USD) FOB TIANJIN
yjm BSIN256	4 1/2	114.300	5 3/4	146.050	18	457.20		4.00	53.48	24.24	238.596
yjm BSIN257	4 1/2	114.300	5 3/4	146.050	18	457.20		4.25	54.29	24.60	242.105
yjm BSIN258	4 1/2	114.300	5 3/4	146.050	18	457.20	3/16	4.76	55.92	25.34	261.404
yjm BSIN259	4 5/8	117.475	6 1/8	155.575	18 1/2	469.90		5.00	64.03	29.02	314.035
yjm BSIN260	4 5/8	117.480	6 1/8	155.580	18 1/2	469.90		5.00	64.04	29.02	314.035
yjm BSIN261	4 5/8	117.480	6 1/8	155.580	18 1/2	469.90	1/4	6.35	68.72	31.15	350.877
yjm BSIN262	4 3/4	120.650	6	152.400	19	482.60		5.00	62.41	28.29	308.772
yjm BSIN263	4 3/4	120.650	6 1/8	155.575	19	482.60		5.00	64.74	29.34	319.298
yjm BSIN264	4 3/4	120.650	6 1/8	155.580	19	482.60		5.00	64.75	29.34	319.298
yjm BSIN265	4 3/4	120.650	6 1/8	155.580	19	482.60	1/4	6.35	69.55	31.52	356.140
yjm BSIN266	4 7/8	123.825	6 1/8	155.575	19	482.60		5.00	63.77	28.90	315.789
yjm BSIN267	4 7/8	123.830	6 1/8	155.580	19	482.60		5.00	63.77	28.90	315.789
yjm BSIN268	4 7/8	123.830	6 1/8	155.580	19	482.60	1/4	6.35	68.58	31.08	354.386
yjm BSIN269	4 7/8	123.825	6 1/8	155.575	19 1/2	495.30		5.00	65.38	29.63	322.807
yjm BSIN270	4 7/8	123.830	6 1/8	155.580	19 1/2	495.30		5.00	65.38	29.63	321.053
yjm BSIN271	4 7/8	123.830	6 1/8	155.580	19 1/2	495.30	1/4	6.35	70.31	31.86	363.158
yjm BSIN272	5	127.000	6	152.400	20	508.00		5.20	64.23	29.11	321.053
yjm BSIN273	5	127.000	6 1/8	155.575	20	508.00		5.20	66.69	30.23	326.316
yjm BSIN274	5	127.000	6 1/8	155.580	20	508.00		5.20	66.70	30.23	329.825
yjm BSIN275	5	127.000	6 1/8	155.575	20	508.00		5.75	68.76	31.16	347.368
yjm BSIN276	5	127.000	6 1/8	155.575	20	508.00		6.00	69.69	31.58	356.140
yjm BSIN277	5	127.000	6 1/8	155.580	20	508.00	1/4	6.35	70.99	32.17	364.912
yjm BSIN278	5	127.000	6 1/4	158.750	20	508.00		5.20	69.19	31.36	342.105
yjm BSIN279	5	127.000	6 1/4	158.750	20	508.00	1/4	6.35	73.58	33.35	391.228
yjm BSIN280	5	127.000	6 1/2	165.100	20	508.00		5.20	74.25	33.65	385.965
yjm BSIN281	5	127.000	6 1/2	165.100	20	508.00		5.75	76.46	34.65	403.509
yjm BSIN282	5	127.000	6 1/2	165.100	20	508.00	1/4	6.35	78.84	35.73	412.281
yjm BSIN283	5	127.000	6 3/4	171.450	20	508.00		6.00	82.77	37.51	426.316
yjm BSIN284	5 1/4	133.350	6 3/4	171.450	20	508.00		5.50	78.50	35.58	403.509
yjm BSIN285	5 1/4	133.350	6 3/4	171.450	21	533.40		5.50	82.27	37.29	421.053
yjm BSIN286	5 1/4	133.350	6 3/4	171.450	21	533.40	1/4	6.35	85.98	38.97	452.632
yjm BSIN287	5 1/4	133.350	7	177.800	21	533.40		5.50	87.86	39.82	443.860
yjm BSIN288	5 1/4	133.350	7	177.800	21	533.40	1/4	6.35	91.72	41.57	473.684
yjm BSIN289	5 3/8	136.525	6 3/4	171.450	21 1/2	546.10		5.50	82.95	37.59	436.842
yjm BSIN290	5 3/8	136.530	6 3/4	171.450	21 1/2	546.10		5.50	82.95	37.59	412.281
yjm BSIN291	5 3/8	136.530	6 3/4	171.450	21 1/2	546.10	1/4	6.35	86.74	39.31	447.368
yjm BSIN292	5 3/8	136.525	7	177.800	21 1/2	546.10		5.50	88.66	40.18	445.614
yjm BSIN293	5 3/8	136.530	7	177.800	21 1/2	546.10		5.50	88.66	40.18	447.368

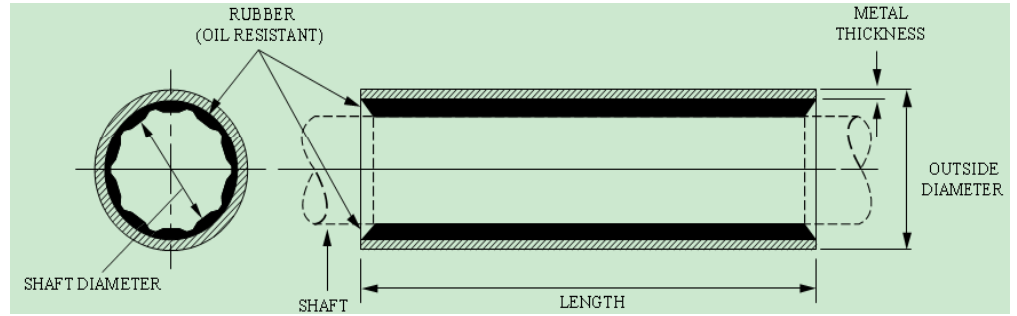

INCH SIZE SERIE

YJM Part Number	Shaft Diameter Dimensions		Outside Diameter Dimensions		Length Dimensions		Metal Thickness Dimensions		Weight		Price
	inches	mm	inches	mm	inches	mm	inches	mm	lb.	kg.	(USD) FOB TIANJIN
yjm BSIN294	5 3/8	136.530	7	177.800	21 1/2	546.10	1/4	6.35	92.61	41.97	477.193
yjm BSIN295	5 1/2	139.700	7	177.800	22	558.80		5.50	89.38	40.51	447.368
yjm BSIN296	5 1/2	139.700	7	177.800	22	558.80		6.00	91.76	41.59	464.912
yjm BSIN297	5 1/2	139.700	7	177.800	22	558.80	1/4	6.35	93.42	42.34	482.456
yjm BSIN298	5 5/8	142.875	7	177.800	22 1/2	571.50		5.50	90.01	40.80	447.368
yjm BSIN299	5 5/8	142.880	7	177.800	22 1/2	571.50		5.50	90.01	40.79	452.632
yjm BSIN300	5 5/8	142.880	7	177.800	22 1/2	571.50	1/4	6.35	94.14	42.66	482.456
yjm BSIN301	5 5/8	142.875	7	177.800	22 1/2	571.50		7.00	97.27	44.08	508.772
yjm BSIN302	5 3/4	146.050	7	177.800	23	584.20		5.50	90.56	41.04	447.368
yjm BSIN303	5 3/4	146.050	7	177.800	23	584.20	1/4	6.35	94.78	42.95	485.965
yjm BSIN304	5 7/8	149.230	7 1/2	190.500	24	609.60		5.50	105.98	48.03	535.088
yjm BSIN305	5 7/8	149.230	7 1/2	190.500	24	609.60	1/4	6.35	110.73	50.18	575.439
yjm BSIN306	6	152.400	7 1/2	190.500	24	609.60		5.50	104.48	47.35	543.860
yjm BSIN307	6	152.400	7 1/2	190.500	24	609.60		6.00	107.27	48.62	561.404
yjm BSIN308	6	152.400	7 1/2	190.500	24	609.60	1/4	6.35	109.22	49.50	578.947
yjm BSIN309	6	152.400	7 3/4	196.850	24.5	622.30		5.50	113.46	51.42	582.456
yjm BSIN310	6	152.400	7 3/4	196.850	24 1/2	622.30		7.94	127.73	57.89	698.246
yjm BSIN311	6	152.400	7 3/4	196.850	24 1/2	622.30	7/16	11.11	145.69	66.03	824.561
yjm BSIN312	6 1/4	158.750	8	203.200	25	635.00		6.00	122.73	55.62	684.211
yjm BSIN313	6 1/4	158.750	8	203.200	25	635.00	7/16	11.11	153.68	69.65	859.649
yjm BSIN314	6 1/2	165.100	8 3/8	212.725	26	660.40		7.00	142.31	64.50	807.018
yjm BSIN315	6 1/2	165.100	8 3/8	212.730	26	660.40		7.00	142.32	64.50	859.649
yjm BSIN316	6 1/2	165.100	8 3/8	212.730	26	660.40	7/16	11.11	169.41	76.78	982.456
yjm BSIN317	6 1/2	165.100	8 3/8	212.725	30	762.00		7.00	163.56	74.13	929.825
yjm BSIN318	6 1/2	165.100	8 3/8	212.730	30	762.00		7.00	163.57	74.13	1017.544
yjm BSIN319	6 1/2	165.100	8 3/8	212.725	30	762.00		8.00	171.26	77.62	1035.088
yjm BSIN320	6 1/2	165.100	8 3/8	212.730	30	762.00	7/16	11.11	194.71	88.24	1140.351
yjm BSIN321	6 8/9	174.900	9	228.600		446.00		9.00	117.52	53.26	719.298
yjm BSIN322	6 8/9	174.900	9	228.600		648.00		9.00	168.46	76.35	1052.632
yjm BSIN323	7	177.800	9	228.600	28	711.20		9.00	182.53	82.72	1035.088
yjm BSIN324	7	177.800	9 1/8	231.775	13 3/4	349.25		9.00	94.58	42.86	614.035
yjm BSIN325	7	177.800	9 1/8	231.775	26 3/8	669.93		9.00	176.71	80.09	1140.351
yjm BSIN326	8	203.200	10 1/4	260.350		370.00		10.00	118.89	53.88	684.167

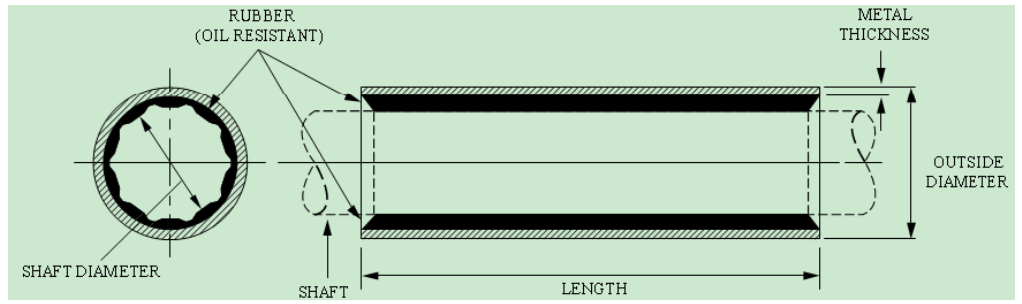
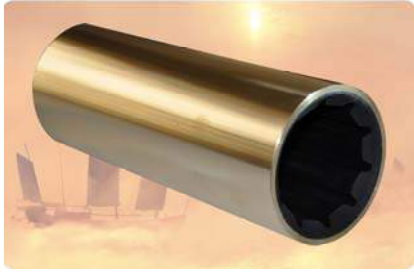

INCH&MM SIZE SERIE

YJM Part Number	Shaft Diameter Dimensions		Outside Diameter Dimensions		Length Dimensions		Metal Thickness Dimensions		Weight		Price (USD) FOB TIANJIN
	inches	mm	inches	mm	inches	mm	inches	mm	lb.	kg.	
yjm BSIM 001	1 1/2	38.100		55.000		152.00		2.50	5.84	2.65	24.912
yjm BSIM 002	1 1/2	38.100		55.000	6.00	152.40		2.50	5.86	2.65	24.912
yjm BSIM 003	1 1/2	38.100		55.000		152.00	1/8	3.18	6.10	2.76	27.775
yjm BSIM 004	1 1/2	38.100		55.000	6.00	152.40	1/8	3.18	6.11	2.77	27.822
yjm BSIM 005	3	76.200		105.000	12	304.8		3	23.89	10.82	91.228
yjm BSIM 006	3	76.200		105.000	12	304.80	1/8	3.18	24.16	10.95	92.982
yjm BSIM 007	3 1/2	90.000		110.000		360.00		4	29.78	13.50	119.092
yjm BSIM 008	3 1/2	90.000		114.000		360.00		4	31.61	14.32	125.351
yjm BSIM 009	3 1/2	90.000		115.000		360.00		4	32.07	14.53	127.135
yjm BSIM 010	3 1/2	90.000		125.000		360.00		5	38.91	17.64	188.817
yjm BSIM 011	3 3/4	95.250		126.000	15	381.00		3.5	37.19	16.85	164.815

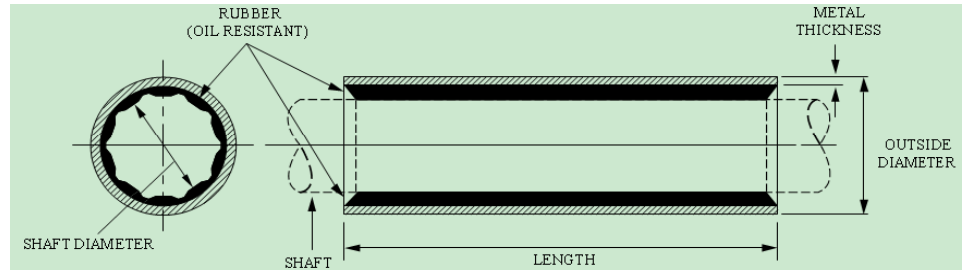
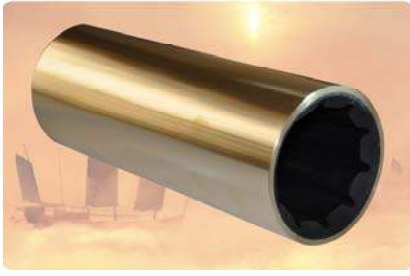

MM&INCH SIZE SERIE

YJM Part Number	Shaft Diameter Dimensions		Outside Diameter Dimensions		Length Dimensions		Metal Thickness Dimensions		Weight		Price (USD) FOB TIANJIN
	inches	mm	inches	mm	inches	mm	inches	mm	lb.	kg.	
yjm BSMI001		20.000	1 1/4	31.750		80.00		2.00	1.80	0.82	11.754
yjm BSMI002		22.000	1 1/4	31.750		88.00		2.00	1.92	0.87	12.105
yjm BSMI003		25.000	1 1/4	31.750		100.00		2.00	2.09	0.95	12.632
yjm BSMI004		25.000	1 3/8	34.930		100.00	1/16	1.59	2.30	1.04	12.855
yjm BSMI005		25.000	1 1/2	38.100		100.00		2.00	2.63	1.19	14.107
yjm BSMI006		25.000	1 1/2	38.100		100.00	1/8	3.18	2.82	1.28	15.414
yjm BSMI007		25.000	1 1/2	38.100	4	101.60	1/8	3.18	2.86	1.30	15.537
yjm BSMI008		28.000	1 5/8	41.275		112.00		2.50	3.25	1.47	17.965
yjm BSMI009		28.000	1 5/8	41.280	4 1/2	112.00	1/8	3.18	3.39	1.53	18.881
yjm BSMI010		30.000	1 3/4	44.450		120.00		2.50	3.75	1.70	19.508
yjm BSMI011		30.000	1 3/4	44.450		120.00	1/8	3.18	3.91	1.77	20.578
yjm BSMI012		30.000	1 3/4	44.450	5	127.00	1/8	3.18	4.11	1.86	21.222
yjm BSMI013		32.000	1 3/4	44.450		128.00		2.50	3.92	1.78	19.995
yjm BSMI014		32.000	1 3/4	44.450		128.00	1/8	3.18	4.09	1.85	21.134
yjm BSMI015		35.000	1 7/8	47.625		140.00		2.20	4.47	2.03	21.339
yjm BSMI016		35.000	1 7/8	47.625		140.00		2.75	4.64	2.10	22.452
yjm BSMI017		35.000	1 7/8	47.630		140.00	1/8	3.18	4.76	2.16	23.303
yjm BSMI018		35.000	2	50.800		140.00		2.20	4.88	2.21	22.673
yjm BSMI019		35.000	2	50.800		140.00	1/8	3.18	5.19	2.35	24.790
yjm BSMI020		38.000	2	50.800		152.00		2.75	5.34	2.42	24.713
yjm BSMI021		40.000	2 1/8	50.000		160.00	1/8	3.18	5.54	2.51	25.864
yjm BSMI022		40.000	2 1/8	53.975		160.00		2.50	5.90	2.67	26.130
yjm BSMI023		40.000	2 1/8	53.975		160.00		2.75	5.99	2.72	26.793
yjm BSMI024		40.000	2 1/8	53.980		160.00	1/8	3.18	6.16	2.79	27.918
yjm BSMI025		40.000	2 1/8	53.980	6 1/2	165.10	1/8	3.18	6.33	2.87	28.494
yjm BSMI026		40.000	2 1/8	56.000		160.00	1/8	3.18	6.47	2.93	27.983
yjm BSMI027		40.000	2 3/8	60.325		160.00		2.75	6.98	3.16	28.953
yjm BSMI028		40.000	2 1/2	63.500		160.00		2.50	7.36	3.34	33.080
yjm BSMI029		40.000	2 1/2	63.500		160.00	1/8	3.18	7.68	3.48	35.117
yjm BSMI030		45.000	2 3/8	60.325		180.00		2.50	7.41	3.36	29.601
yjm BSMI031		45.000	2 3/8	60.325		180.00		2.75	7.54	3.42	30.400
yjm BSMI032		50.000	2 5/8	66.675		200.00		3.00	9.43	4.27	39.770
yjm BSMI033		50.000	2 5/8	66.680		200.00	1/8	3.18	9.54	4.32	40.510
yjm BSMI034		50.000	2 5/8	66.680	8	203.20	1/8	3.18	9.68	4.39	40.931
yjm BSMI035		55.000	2 7/8	73.025		220.00		2.75	11.21	5.08	46.159
yjm BSMI036		55.000	2 7/8	73.025		220.00		4.00	12.13	5.50	52.055
yjm BSMI037		55.000	3	76.200		220.00		3.00	12.13	5.50	46.675
yjm BSMI038		57.150	2 15/16	74.610	9	228.60	3/32	2.38	11.54	5.23	46.296
yjm BSMI039		60.000	3	76.200		240.00		3.00	12.77	5.79	47.988
yjm BSMI040		60.000	3	76.200		240.00	1/8	3.18	12.92	5.85	49.257

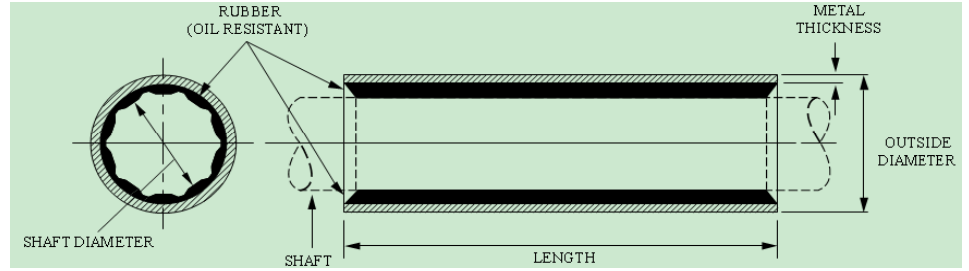
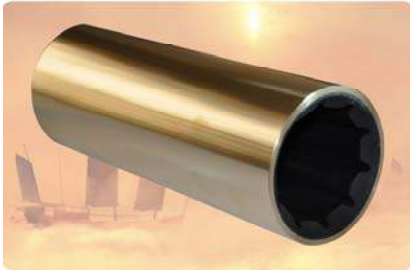

MM&INCH SIZE SERIE

YJM Part Number	Shaft Diameter Dimensions		Outside Diameter Dimensions		Length Dimensions		Metal Thickness Dimensions		Weight		Price
	inches	mm	inches	mm	inches	mm	inches	mm	lb.	kg.	(USD) FOB TIANJIN
yjm BSMI041		60.000	3	78.000		240.00	1/8	3.18	13.38	6.06	52.263
yjm BSMI042		60.000	3	80.000		240.00	1/8	3.18	13.89	6.30	53.873
yjm BSMI043		60.000	3	82.000		240.00	1/8	3.18	14.41	6.53	58.107
yjm BSMI044		60.000	3 1/4	82.550		240.00		3.00	14.39	6.52	56.464
yjm BSMI045		60.000	3 1/4	82.550		240.00	1/8	3.18	14.56	6.60	58.292
yjm BSMI046		60.000	3 1/4	82.550	9 1/2	241.30	1/8	3.18	14.63	6.63	58.824
yjm BSMI047		60.000	3	85.000		240.00	1/8	3.18	15.20	6.89	60.610
yjm BSMI048		65.000	3 1/8	79.375	10	254.00			10.93	4.96	34.973
yjm BSMI049		65.000	3 1/8	79.375	10			3.00	1.01	0.46	18.011
yjm BSMI050		65.000	3 1/8	79.380	10	254.00	1/8	3.18	14.04	6.36	53.769
yjm BSMI051		65.000	3 3/8	85.725		260.00		3.00	15.96	7.23	61.710
yjm BSMI052		65.000	3 3/8	85.725	10 1/2	266.70		3.00	16.34	7.40	62.624
yjm BSMI053		65.000	3 3/8	85.725	10 1/2	266.70		3.00	16.34	7.40	62.624
yjm BSMI054		65.000	3 3/8	85.725	10 1/2	266.70		3.00	16.34	7.40	62.624
yjm BSMI055		65.000	3 3/8	85.730	10	260.00	1/8	3.18	16.15	7.32	62.849
yjm BSMI056		65.000	3 3/8	85.730	10 1/2	266.70	1/8	3.18	16.53	7.49	63.940
yjm BSMI057		65.000	3 1/8	87.000	10	260.00	1/8	3.18	16.51	7.48	65.672
yjm BSMI058		65.000	3 1/8	88.000	10	260.00	1/8	3.18	16.80	7.61	64.643
yjm BSMI059		70.000	3 1/2	88.900		280.00		3.00	17.56	7.96	65.741
yjm BSMI060		70.000	3 1/2	88.900		280.00		4.00	18.72	8.49	72.764
yjm BSMI061		70.000	3 1/2	88.900	11 1/2	280.00		2.80	17.33	7.85	67.202
yjm BSMI062		70.000	3 3/4	95.250	11	279.40		2.80	19.27	8.73	70.291
yjm BSMI063		70.000	3 3/4	95.250	11	279.40		3.00	19.52	8.85	71.986
yjm BSMI064		70.000	3 3/4	95.250	11	279.40		3.00	19.52	8.85	71.986
yjm BSMI065		70.000	3 3/4	95.250	11	279.40		4.00	20.78	9.42	79.400
yjm BSMI066		70.000	3 3/4	95.250	11 1/2	280.00		2.80	19.30	8.75	70.470
yjm BSMI067		70.000	3 3/4	95.250		280.00		3.00	19.56	8.86	71.990
yjm BSMI068		72.000	3 1/2	88.900		288.00		3.00	17.81	8.07	66.315
yjm BSMI069		72.000	3 1/2	88.900		288.00		4.00	19.00	8.61	73.529
yjm BSMI070		75.000	4	101.600		300.00		4.00	23.92	10.84	98.126
yjm BSMI071		75.000	4	101.600	12	304.80		4.00	24.28	11.00	99.046
yjm BSMI072		75.000	4	101.600	12	304.80		4.00	24.28	11.00	100.794
yjm BSMI073		80.000	4	101.600	12	304.80		4.00	23.65	10.72	94.737
yjm BSMI074		80.000	4	101.600	12	304.80		4.00	23.65	10.72	94.737
yjm BSMI075		80.000	4	101.600		320.00		4.00	24.76	11.22	98.246
yjm BSMI076		85.000	4 1/2	114.300		340.00		4.00	30.86	13.99	125.149
yjm BSMI077		95.000	4 1/2	114.300	15	380.00		4.00	32.49	14.72	126.449
yjm BSMI078		100.000	5 1/4	133.350		400.00		5.00	45.70	20.71	209.034
yjm BSMI079		105.000	5 1/4	133.350		420.00		5.00	46.75	21.19	215.789
yjm BSMI080		108.000	5 1/2	139.700	17	432.00		5.00	51.24	23.22	238.596

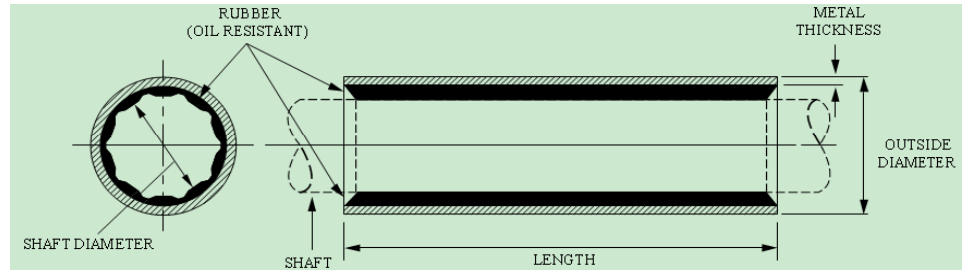
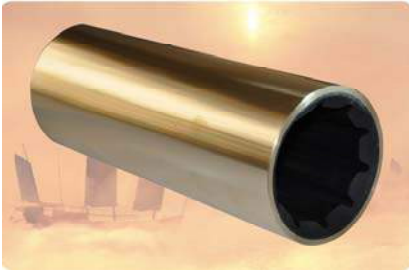

MM&INCH SIZE SERIE

YJM Part Number	Shaft Diameter Dimensions		Outside Diameter Dimensions		Length Dimensions		Metal Thickness Dimensions		Weight		Price (USD) FOB TIANJIN
	inches	mm	inches	mm	inches	mm	inches	mm	lb.	kg.	
yjm BSMI081		110.000	5 1/2	139.700	17	431.80		5.00	50.73	22.99	235.088
yjm BSMI082		110.000	5 1/2	139.700	17	440.00		5.00	51.65	23.41	238.596
yjm BSMI083		110.000	5 3/4	146.050		440.00		5.00	55.75	25.27	259.649
yjm BSMI084		115.000	5 1/2	139.700		460.00		5.00	52.54	23.81	242.105
yjm BSMI085		120.000	6 1/8	155.575		480.00		6.00	68.16	30.89	347.368
yjm BSMI086		120.000	6 1/8	155.575		480.00		6.50	69.91	31.68	361.404
yjm BSMI087		120.000	6 1/8	155.580		480.00		6.50	69.92	31.69	336.842
yjm BSMI088		123.000	6 1/8	155.575		492.00		6.00	68.86	31.21	347.368
yjm BSMI089		123.000	6 1/8	155.575		492.00		6.50	70.66	32.02	364.912
yjm BSMI090		123.000	6 1/8	155.580		492.00		6.50	70.66	32.02	364.912
yjm BSMI091		125.000	6 1/8	155.575		500.00		6.00	69.29	31.40	345.614
yjm BSMI092		125.000	6 1/8	155.575		500.00		7.00	72.93	33.05	377.193
yjm BSMI093		125.000	6 1/8	155.580		500.00		7.00	72.93	33.05	382.456

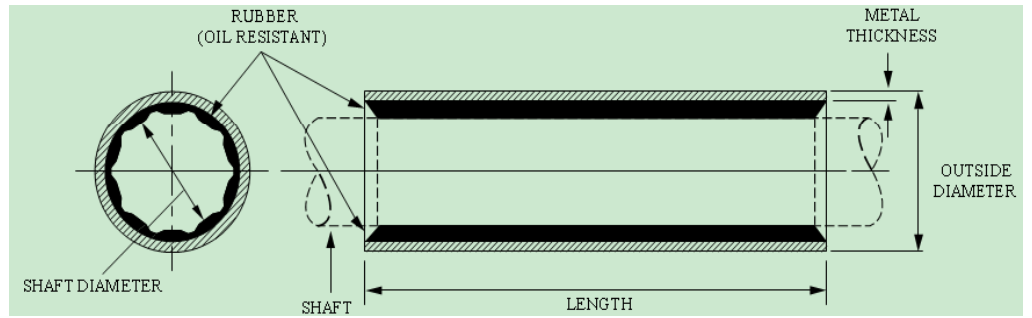
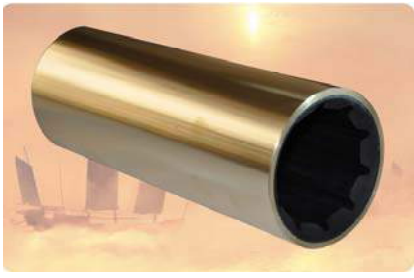

MM SIZE SERIE

YJM Part Number	Shaft Diameter Dimensions		Outside Diameter Dimensions		Length Dimensions		Metal Thickness Dimensions		Weight		Price (USD)
	inches	mm	inches	mm	inches	mm	inches	mm	lb.	kg.	FOB TIANJIN
yjm BSMM001		20.000		35.000		80.00		2.00	2.03	0.92	12.370
yjm BSMM002		20.000		35.000		80.00	1/8	3.18	2.17	0.98	13.313
yjm BSMM003		22.000		35.000		88.00		2.00	2.17	0.98	12.760
yjm BSMM004		22.000		35.000		88.00		2.50	2.23	1.01	13.211
yjm BSMM005		22.000		35.000		88.00	1/8	3.18	2.32	1.05	13.794
yjm BSMM006		25.000		35.000		100.00	1/16	1.59	2.30	1.04	12.871
yjm BSMM007		25.000		35.000		100.00		2.00	2.37	1.07	13.303
yjm BSMM008		25.000		35.000		100.00		2.50	2.44	1.11	13.813
yjm BSMM009		25.000		40.000		100.00		2.50	2.89	1.31	16.869
yjm BSMM010		25.000		40.000		100.00		2.54	2.89	1.31	16.916
yjm BSMM011		25.000		40.000		100.00	1/8	3.18	3.00	1.36	17.656
yjm BSMM012		25.000		43.000		100.00		2.50	3.16	1.43	17.736
yjm BSMM013		25.000		43.000		100.00	1/8	3.18	3.29	1.49	18.598
yjm BSMM014		28.000		38.000		112.00		2.50	2.92	1.33	15.278
yjm BSMM015		28.000		38.000		114.00	1/16	1.59	2.80	1.27	14.234
yjm BSMM016		28.000		42.000		112.00		2.50	3.33	1.51	18.197
yjm BSMM017		28.000		42.000		112.00	1/8	3.18	3.46	1.57	19.131
yjm BSMM018		30.000		40.000		120.00		2.00	3.17	1.44	17.272
yjm BSMM019		30.000		40.000		120.00		2.50	3.27	1.48	17.988
yjm BSMM020		30.000		40.000		120.00		3.07	3.39	1.53	18.778
yjm BSMM021		30.000		40.000		120.00	1/8	3.18	3.41	1.54	18.927
yjm BSMM022		30.000		43.000		120.00		2.50	3.60	1.63	19.007
yjm BSMM023		30.000		43.000		120.00	1/8	3.18	3.74	1.70	20.034
yjm BSMM024		30.000		45.000		120.00		2.50	3.81	1.73	19.699
yjm BSMM025		30.000		45.000		120.00		3.07	3.95	1.79	20.613
yjm BSMM026		30.000		45.000		120.00	1/8	3.18	3.97	1.80	20.786
yjm BSMM027		30.000		50.000		120.00		3.00	4.51	2.04	22.390
yjm BSMM028		30.000		50.000		120.00	1/8	3.18	4.56	2.07	22.712
yjm BSMM029		32.000		45.000		128.00		2.50	3.99	1.81	20.198
yjm BSMM030		32.000		45.000		128.00		3.07	4.13	1.87	21.170
yjm BSMM031		32.000		45.000		128.00	1/8	3.18	4.15	1.88	21.355
yjm BSMM032		32.000		50.000		120.00		3.00	4.47	2.02	22.220
yjm BSMM033		32.000		50.000		120.00	1/8	3.18	4.51	2.05	22.543
yjm BSMM034		32.000		50.000		128.00		3.00	4.72	2.14	23.053
yjm BSMM035		32.000		50.000		128.00	1/8	3.18	4.77	2.16	23.396
yjm BSMM036		35.000		48.000		140.00		2.50	4.61	2.09	22.104
yjm BSMM037		35.000		48.000		140.00		3.07	4.78	2.16	23.250
yjm BSMM038		35.000		48.000		140.00	1/8	3.18	4.81	2.18	23.468

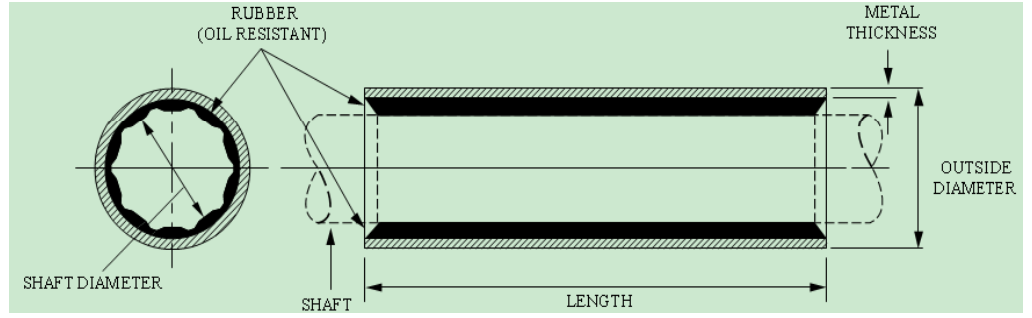
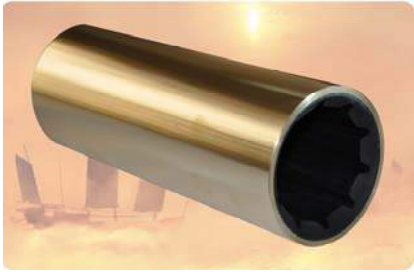

MM SIZE SERIE

YJM Part Number	Shaft Diameter Dimensions		Outside Diameter Dimensions		Length Dimensions		Metal Thickness Dimensions		Weight		Price (USD)
	inches	mm	inches	mm	inches	mm	inches	mm	lb.	kg.	FOB TIANJIN
yjm BSMM039		35.000		50.000		140.00		2.75	4.95	2.24	23.462
yjm BSMM040		35.000		50.000		140.00		3.07	5.04	2.29	24.134
yjm BSMM041		35.000		50.000		140.00	1/8	3.18	5.08	2.30	24.363
yjm BSMM042		35.000		54.000		140.00		2.75	5.48	2.48	25.270
yjm BSMM043		35.000		54.000		140.00	1/8	3.18	5.63	2.55	26.256
yjm BSMM044		35.000		55.000		140.00		2.75	5.62	2.54	25.713
yjm BSMM045		35.000		55.000		140.00	1/8	3.18	5.76	2.61	26.721
yjm BSMM046		38.000		50.800		152.00	1/8	3.18	5.48	2.48	25.707
yjm BSMM047		38.000		55.000		152.00		2.75	5.94	2.69	26.696
yjm BSMM048		38.000		55.000		152.00		3.07	6.06	2.75	27.511
yjm BSMM049		38.000		55.000	6	152.40	1/8	3.18	6.12	2.77	27.835
yjm BSMM050		40.000		50.000		160.00		2.75	5.40	2.45	24.839
yjm BSMM051		40.000		55.000		160.00		2.75	6.15	2.79	27.306
yjm BSMM052		40.000		55.000		160.00		3.07	6.27	2.84	28.162
yjm BSMM053		40.000		55.000		160.00	1/8	3.18	6.32	2.86	26.660
yjm BSMM054		40.000		56.000		160.00		2.75	6.30	2.86	26.874
yjm BSMM055		40.000		56.000		160.00		3.07	6.43	2.91	27.701
yjm BSMM056		40.000		60.000		160.00		2.75	6.92	3.14	28.794
yjm BSMM057		42.000		60.000		168.00		2.75	7.15	3.24	29.397
yjm BSMM058		42.000		60.000		168.00		3.75	7.60	3.45	32.296
yjm BSMM059		45.000		60.330		180.00	1/8	3.18	7.75	3.51	31.761
yjm BSMM060		45.000		61.000		180.00		2.75	7.66	3.47	34.083
yjm BSMM061		45.000		61.000		180.00	1/8	3.18	7.87	3.57	35.457
yjm BSMM062		45.000		61.000		180.00		3.30	7.93	3.59	35.837
yjm BSMM063		45.000		65.000		180.00		2.75	8.37	3.79	36.301
yjm BSMM064		45.000		65.000		180.00	1/8	3.18	8.60	3.90	38.246
yjm BSMM065		45.000		65.000		180.00		3.30	8.66	3.93	38.421
yjm BSMM066		45.000		67.000		180.00		2.75	8.73	3.96	37.467
yjm BSMM067		45.000		67.000		180.00	1/8	3.18	8.97	4.06	38.997
yjm BSMM068		45.000		70.000		180.00	1/8	3.18	9.53	4.32	40.804
yjm BSMM069		45.000		70.000		180.00		4.00	10.00	4.53	43.808
yjm BSMM070		50.000		65.000		200.00		2.75	8.94	4.05	37.741
yjm BSMM071		50.000		65.000		200.00	1/8	3.18	9.20	4.17	39.381
yjm BSMM072		50.000		66.000		200.00		2.75	9.14	4.14	38.363
yjm BSMM073		50.000		66.000		200.00		3.00	9.29	4.21	39.336
yjm BSMM074		50.000		66.000		200.00	1/8	3.18	9.40	4.26	40.032
yjm BSMM075		50.000		70.000		200.00		3.00	10.11	4.58	41.969
yjm BSMM076		50.000		70.000		200.00	1/8	3.18	10.22	4.63	42.712

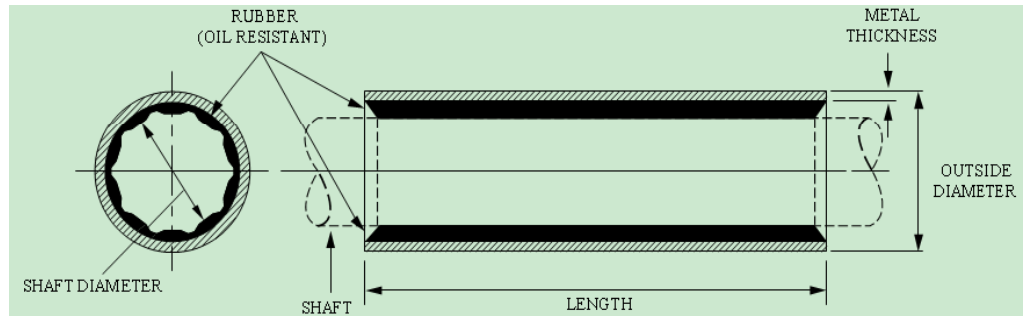
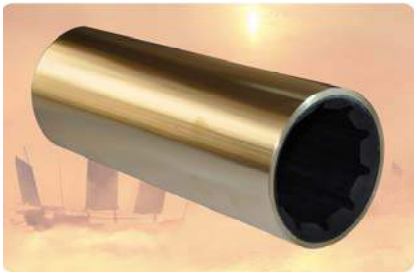

MM SIZE SERIE

YJM Part Number	Shaft Diameter Dimensions		Outside Diameter Dimensions		Length Dimensions		Metal Thickness Dimensions		Weight		Price (USD)
	inches	mm	inches	mm	inches	mm	inches	mm	lb.	kg.	FOB TIANJIN
yjm BSMM077		50.000		70.000		200.00		3.26	10.28	4.66	43.041
yjm BSMM078		50.000		75.000		200.00		3.00	11.15	5.05	44.260
yjm BSMM079		50.000		75.000		200.00	1/8	3.18	11.28	5.11	45.018
yjm BSMM080		55.000		73.000		220.00		2.75	11.21	5.08	46.141
yjm BSMM081		55.000		73.000		220.00		3.00	11.39	5.16	47.338
yjm BSMM082		55.000		75.000		220.00		2.58	11.53	5.22	43.874
yjm BSMM083		55.000		75.000		220.00		3.00	11.85	5.37	45.833
yjm BSMM084		55.000		78.000		220.00		3.00	12.55	5.69	49.981
yjm BSMM085		55.000		78.000		220.00		4.00	13.34	6.05	57.895
yjm BSMM086		55.000		80.000		220.00		3.00	13.02	5.90	51.412
yjm BSMM087		60.000		78.000		240.00		3.00	13.22	5.99	51.314
yjm BSMM088		60.000		80.000		240.00		3.00	13.73	6.22	52.922
yjm BSMM089		60.000		80.000		240.00		3.26	13.96	6.33	54.737
yjm BSMM090		60.000		82.000		240.00		3.00	14.25	6.46	55.580
yjm BSMM091		60.000		85.000		228.00		3.00	14.34	6.50	57.659
yjm BSMM092		60.000		85.000		240.00		3.00	15.03	6.81	59.479
yjm BSMM093		65.000		83.000		260.00		2.82	15.00	6.80	58.249
yjm BSMM094		65.000		83.000		260.00		3.00	15.19	6.88	59.210
yjm BSMM095		65.000		83.000		260.00	1/8	3.18	15.37	6.96	60.696
yjm BSMM096		65.000		85.000		260.00		2.82	15.56	7.05	59.858
yjm BSMM097		65.000		85.000		260.00		3.00	15.75	7.14	60.997
yjm BSMM098		65.000		85.000		260.00	1/8	3.18	15.94	7.22	62.135
yjm BSMM099		65.000		87.000		260.00		3.00	16.32	7.40	62.783
yjm BSMM100		65.000		87.000		260.00		4.00	17.37	7.87	72.807
yjm BSMM101		65.000		88.000		260.00		3.00	16.61	7.53	63.676
yjm BSMM102		70.000		90.000	11 1/2	280.00		2.80	17.67	8.01	76.841
yjm BSMM103		70.000		90.000		280.00		3.00	17.91	8.11	67.337
yjm BSMM104		70.000		90.000		280.00		4.76	19.95	9.04	79.681
yjm BSMM105		70.000		95.000	11 1/2	280.00		2.80	19.23	8.71	71.689
yjm BSMM106		70.000		95.000		280.00		4.00	20.73	9.40	81.147
yjm BSMM107		70.000		95.000		280.00		4.75	21.65	9.81	85.956
yjm BSMM108		75.000		95.000		300.00		3.05	20.27	9.18	73.724
yjm BSMM109		75.000		95.000		300.00		4.00	21.54	9.76	81.323
yjm BSMM110		75.000		96.000		300.00		4.00	21.89	9.92	83.100
yjm BSMM111		75.000		100.000		300.00		4.00	23.34	10.58	90.211
yjm BSMM112		75.000		100.000	12	304.80		4.00	23.69	10.74	90.955
yjm BSMM113		75.000		110.000		300.00		7.00	31.62	14.33	141.612
yjm BSMM114		76.200		103.600	12	304.80		5.00	26.35	11.94	0.000

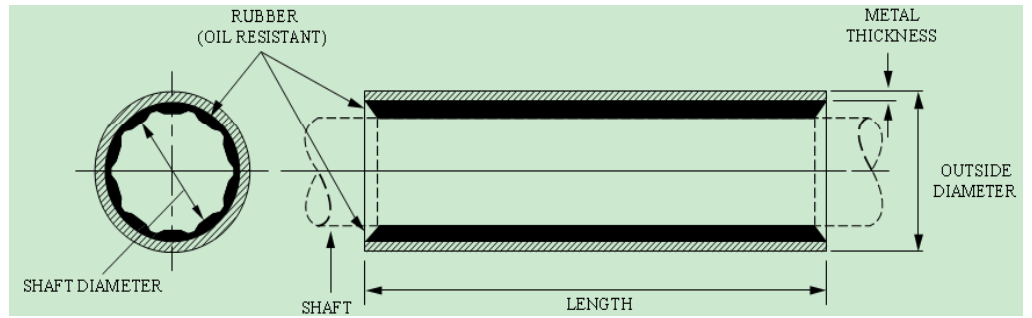
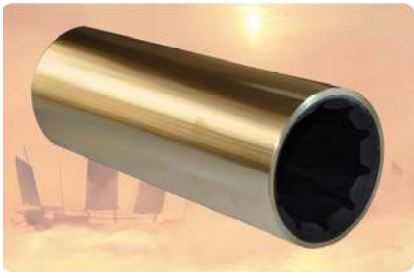

MM SIZE SERIE

YJM Part Number	Shaft Diameter Dimensions		Outside Diameter Dimensions		Length Dimensions		Metal Thickness Dimensions		Weight		Price (USD)
	inches	mm	inches	mm	inches	mm	inches	mm	lb.	kg.	FOB TIANJIN
yjm BSMM115		80.000		100.000		320.00		3.17	22.89	10.37	86.304
yjm BSMM116		80.000		100.000		320.00		4.00	24.14	10.94	95.642
yjm BSMM117		80.000		102.000		320.00		4.00	24.91	11.29	98.246
yjm BSMM118		80.000		106.000		320.00		4.50	27.28	12.37	114.035
yjm BSMM119		80.000		110.000		320.00		5.50	30.56	13.85	132.087
yjm BSMM120		85.000		105.000		340.00		3.19	25.52	11.57	96.491
yjm BSMM121		85.000		105.000		340.00		4.00	26.89	12.19	105.263
yjm BSMM122		85.000		110.000		340.00		4.00	29.00	13.14	117.139
yjm BSMM123		85.000		115.000		340.00		3.50	30.23	13.70	121.234
yjm BSMM124		85.000		115.000		340.00		4.00	31.17	14.13	125.172
yjm BSMM125		88.900		116.300	14	355.60		5.00	34.42	15.60	0.000
yjm BSMM126		90.000		110.000		360.00		3.50	28.85	13.07	113.401
yjm BSMM127		90.000		110.000		360.00		4.78	31.22	14.15	128.521
yjm BSMM128		90.000		120.000		360.00		3.50	33.36	15.12	140.351
yjm BSMM129		90.000		120.000		360.00		4.00	34.40	15.59	163.155
yjm BSMM130		95.000		115.000		380.00		4.00	32.83	14.88	128.223
yjm BSMM131		95.000		115.000		380.00		4.51	33.88	15.35	133.967
yjm BSMM132		95.000		125.000		360.00		4.00	35.90	16.27	168.575
yjm BSMM133		100.000		125.000		400.00		3.77	38.10	17.27	174.028
yjm BSMM134		100.000		125.000		400.00		4.00	38.65	17.52	177.785
yjm BSMM135		100.000		125.000		400.00		4.76	40.45	18.33	192.627
yjm BSMM136		100.000		125.000		400.00		5.00	41.01	18.59	191.145
yjm BSMM137		100.000		126.000		400.00		4.00	39.18	17.76	176.075
yjm BSMM138		100.000		126.000		400.00		4.76	41.00	18.58	189.175
yjm BSMM139		100.000		130.000		400.00		4.00	41.33	18.73	183.224
yjm BSMM140		100.000		130.000		400.00		4.76	43.21	19.58	196.354
yjm BSMM141		105.000		130.000		420.00		4.52	43.52	19.72	194.599
yjm BSMM142		105.000		130.000		420.00		5.00	44.76	20.29	203.928
yjm BSMM143		105.000		131.000		420.00		4.00	42.74	19.37	188.754
yjm BSMM144		105.000		131.000		420.00		5.00	45.35	20.55	209.225
yjm BSMM145		110.000		135.000		440.00		4.51	47.29	21.43	214.035
yjm BSMM146		110.000		135.000		440.00		5.00	48.67	22.06	226.316
yjm BSMM147		110.000		145.000		440.00		5.00	55.07	24.96	254.386
yjm BSMM148		110.000		150.000		440.00		5.00	58.35	26.45	289.474
yjm BSMM149		115.000		145.000		460.00		4.25	53.72	24.34	236.842
yjm BSMM150		115.000		145.000		460.00		5.00	56.11	25.43	259.649
yjm BSMM151		120.000		150.000		480.00		6.00	63.96	28.99	324.561
yjm BSMM152		120.000		155.000		480.00		6.00	67.72	30.69	347.368

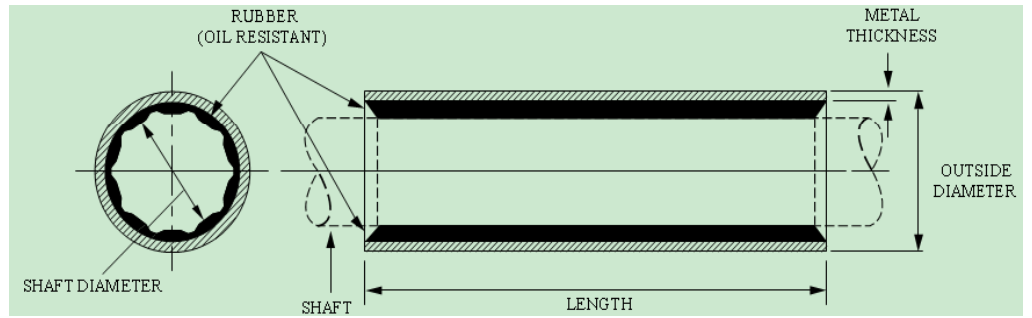
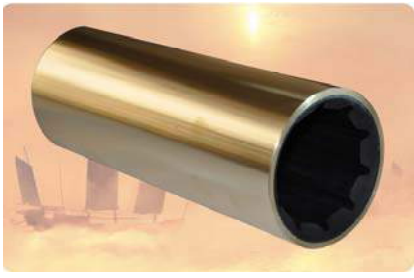

MM SIZE SERIE

YJM Part Number	Shaft Diameter Dimensions		Outside Diameter Dimensions		Length Dimensions		Metal Thickness Dimensions		Weight		Price (USD)
	inches	mm	inches	mm	inches	mm	inches	mm	lb.	kg.	FOB TIANJIN
yjm BSMM153		120.000		155		480.00		6.06	67.93	30.79	349.123
yjm BSMM154		120.000		155		480.00		6.50	69.47	31.48	359.649
yjm BSMM155		125.000		155.000		500.00		7.00	72.46	32.84	377.193
yjm BSMM156		125.000		165.000		500.00		6.00	76.85	34.83	401.754
yjm BSMM157		125.000		165.000		500.00		7.00	80.75	36.60	429.825
yjm BSMM158		130.000		170.000		520.00		5.63	80.79	36.62	403.509
yjm BSMM159		130.000		170.000		520.00		6.50	84.45	38.27	447.368
yjm BSMM160		130.000		170.000		520.00		7.00	86.54	39.22	464.912
yjm BSMM161		130.000		182.000		520.00		7.00	97.39	44.14	508.772
yjm BSMM162		130.000		182.000		520.00		8.00	101.85	46.16	543.860
yjm BSMM163		135.000		170.000		540.00		7.00	87.89	39.83	470.175
yjm BSMM164		135.000		175.000		540.00		7.00	92.52	41.93	491.228
yjm BSMM165		135.000		178.000		540.00		7.00	95.34	43.21	500.000
yjm BSMM166		140.000		180.000		560.00		6.50	96.32	43.65	500.000
yjm BSMM167		140.000		180.000		560.00		7.00	98.71	44.74	517.544
yjm BSMM168		140.000		180.000		560.00		7.45	100.85	45.70	535.088
yjm BSMM169		140.000		190.000		280.00		7.00	56.22	25.48	324.561
yjm BSMM170		140.000		190.000		560.00		7.00	108.68	49.26	566.667
yjm BSMM171		140.000		200.000		560.00		7.00	118.95	53.91	614.035
yjm BSMM172		140.000		200.000		560.00		9.50	132.16	59.90	719.298
yjm BSMM173		145.000		180.000		580.00		7.00	99.98	45.31	522.807
yjm BSMM174		150.000		190.000		600.00		6.50	108.97	49.38	561.404
yjm BSMM175		150.000		190.000		600.00		8.00	117.06	53.05	631.579
yjm BSMM176		150.000		195.000		620.00		8.00	126.62	57.39	692.982
yjm BSMM177		150.000		200.000		600.00		8.00	128.35	58.17	666.667
yjm BSMM178		150.000		200.000		600.00		8.50	131.17	59.45	692.982
yjm BSMM179		155.000		195		620.00		8.00	165.93	75.20	691.667
yjm BSMM180		160.000		200.000		640.00		8.00	131.51	59.60	684.211
yjm BSMM181		160.000		200.000		640.00		9.00	137.51	62.32	728.070
yjm BSMM182		160.000		200.000		640.00		11.11	149.94	67.95	842.105
yjm BSMM183		160.000		205.000		640.00		6.50	128.26	58.13	692.982
yjm BSMM184		160.000		205.000		640.00		9.00	143.81	65.18	824.561
yjm BSMM185		160.000		205.000		640.00		11.11	156.61	70.97	929.825
yjm BSMM186		165.000		205.000		660.00		8.50	142.24	64.46	789.474
yjm BSMM187		165.000		205.000		660.00		11.11	158.59	71.87	947.368
yjm BSMM188		170.000		210.000		680.00		8.50	150.17	68.06	859.649
yjm BSMM189		175.000		215.000		700.00		8.50	158.32	71.75	929.825
yjm BSMM190		180.000		220.000		720.00		9.00	170.42	77.23	1087.719

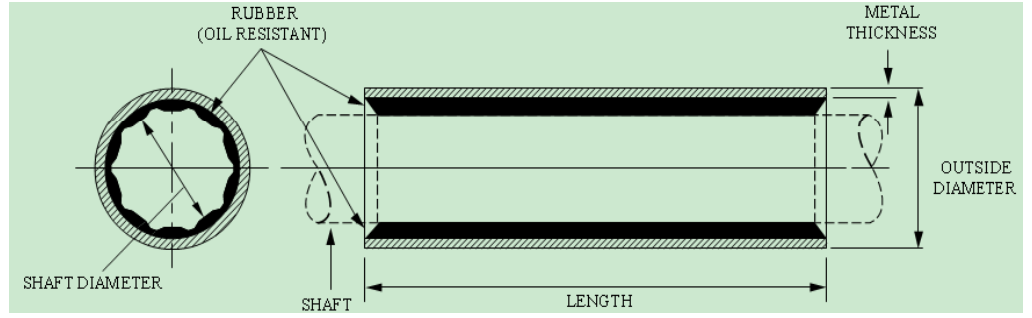
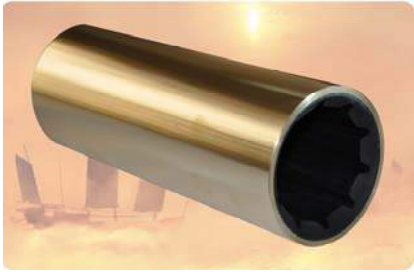

MM SIZE SERIE

YJM Part Number	Shaft Diameter Dimensions		Outside Diameter Dimensions		Length Dimensions		Metal Thickness Dimensions		Weight		Price (USD)
	inches	mm	inches	mm	inches	mm	inches	mm	lb.	kg.	FOB TIANJIN
yjm BSMM191		180.000		230.000		720.00		9.00	185.39	84.02	1192.982
yjm BSMM192		185.000		235.000		740.00		9.00	194.75	88.26	1280.702
yjm BSMM193		190.000		240.000		760.00		9.00	204.35	92.61	1315.789
yjm BSMM194		195.000		245.000		780.00		9.00	214.18	97.07	1368.421
yjm BSMM195		200.000		250.000		800.00		9.00	224.24	101.63	1421.053
yjm BSMM196		200.000		250.000		800.00		10.00	233.73	105.93	1491.228
yjm BSMM197		210.000		250.000		840.00		9.00	226.36	102.59	1491.228
yjm BSMM198		210.000		260.000		840.00		9.00	245.05	111.06	1596.491
yjm BSMM199		210.000		265.000		840.00		9.50	259.87	117.77	1666.667
yjm BSMM200		220.000		270.000		880.00		9.50	272.45	123.48	2017.544
yjm BSMM201		220.000		280.000		380.00		6.50	114.36	51.83	666.667
yjm BSMM202		230.000		285.000		920.00		9.50	306.57	138.94	2192.982
yjm BSMM203		240.000		295.000		960.00		10.00	338.15	153.25	2368.421
yjm BSMM204		250.000		315.000		1000.00		10.00	389.94	176.72	2631.579
yjm BSMM205		260.000		325.000		1040.00		10.00	418.73	189.77	2842.105

yjm Non-Metallic Sleeve Bearings

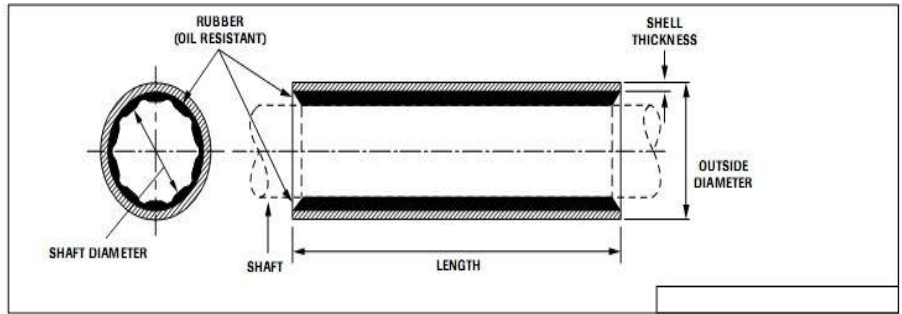

METRIC SIZE SERIES

Part Number	Shaft Diameter (mm)	Outside Diameter (mm)	Length (mm)	Shell Thickness (mm)	Weight		FOB Price USD
					lb.	kg.	
yjm-FS-M001	25	40	100	2.54	0.3	0.1	9.17
yjm-FS-M002	28	42	112	2.35	0.4	0.2	10.33
yjm-FS-M003	30	45	120	3.07	0.4	0.2	12.17
yjm-FS-M004	32	45	128	3.07	0.5	0.2	13.17
yjm-FS-M005	35	50	140	3.07	0.5	0.2	16.83
yjm-FS-M006	38	55	152	3.07	0.6	0.3	18.00
yjm-FS-M007	40	55	160	3.07	0.6	0.3	20.83
yjm-FS-M008	45	65	180	3.3	0.9	0.4	25.83
yjm-FS-M009	50	70	200	3.25	1.1	0.5	28.50
yjm-FS-M010	55	75	220	2.58	1.3	0.6	33.33
yjm-FS-M011	60	80	240	3.25	1.6	0.7	36.67
yjm-FS-M012	65	85	260	2.81	1.8	0.8	42.33
yjm-FS-M013	70	90	280	4.75	2	0.9	53.33
yjm-FS-M014	75	95	300	3.05	2.5	1.1	50.00
yjm-FS-M015	80	100	320	3.16	2.6	1.2	55.00
yjm-FS-M016	85	105	340	3.17	3	1.4	66.67
yjm-FS-M017	90	110	360	4.76	3.4	1.5	90.00
yjm-FS-M018	95	115	380	4.5	4	1.8	93.33
yjm-FS-M019	100	125	400	3.76	4.6	2.1	125.00
yjm-FS-M020	105	130	420	4.51	5.2	2.4	133.33
yjm-FS-M021	110	135	440	4.51	6	2.7	160.00
yjm-FS-M022	115	145	460	4.24	7.6	3.4	183.33
yjm-FS-M023	120	155	480	6.06	8.6	3.9	250.00
yjm-FS-M024	130	170	520	5.63	13	5.9	283.33

yjm Non-Metallic Sleeve Bearings

yjm Non-Metallic Sleeve Bearing feature a dense structure of engineered reinforced thermoset plastic . The specially compounded NBR is securely bonded to the shell with all tolerances maintained for proper lubrication. Being non-corrosive and inherently resistant to all known chemicals, oil and grease , as well as being anti-electrolytic, the yjm Non-metallic Sleeve bearing are ideally suited for installations wherever corrosion or electrolysis is a problem.

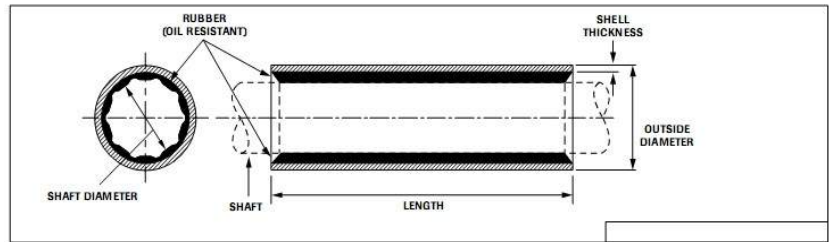

INCH SIZE SERIE NORMAL PRICE AS BELOW:

Part Number	Shaft Diameter		Outside Diameter		Length		Shell Thickness		Weight		Price
	Dimensions		Dimensions		Dimensions		Dimensions		lb.	kg.	
	inches	mm	inches	mm	inches	mm	inches	mm			FOB TIANJIN
yjm-FS-I001	3/4	19.05	1 1/4	31.75	3	76.20	1/8	3.18			7.000
yjm-FS-I002	7/8	22.23	1 1/4	31.75	3 1/2	88.90	1/16	1.59			7.500
yjm-FS-I003	7/8	22.23	1 3/8	34.93	3 1/2	88.90	1/8	3.18			8.667
yjm-FS-I004	7/8	22.23	1 1/2	38.10	3 1/2	88.90	1/8	3.18			9.667
yjm-FS-I005	1	25.40	1 1/4	31.75	4	101.60	3/64	1.19			7.500
yjm-FS-I006	1	25.40	1 1/4	31.75	4	101.60	3/64	1.19			8.333
yjm-FS-I007	1	25.40	1 1/4	31.75	6	152.40	1/16	1.59			10.000
yjm-FS-I008	1	25.40	1 3/8	34.93	4	101.60	1/16	1.59			9.167
yjm-FS-I009	1	25.40	1 1/2	38.10	4	101.60	1/8	3.18			10.500
yjm-FS-I010	1	25.40	1 5/8	41.28	4	101.60	1/8	3.18			11.333
yjm-FS-I011	1	25.40	2	50.80	4	101.60	1/8	3.18			13.667
yjm-FS-I012	1 1/8	28.58	1 1/2	38.10	4 1/2	114.30	1/16	1.59			11.667
yjm-FS-I013	1 1/8	28.58	1 5/8	41.28	4 1/2	114.30	1/8	3.18			13.000
yjm-FS-I014	1 1/8	28.58	1 3/4	44.45	4 1/2	114.30	1/8	3.18			13.333
yjm-FS-I015	1 1/8	28.58	2	50.80	4 1/2	114.30	1/8	3.18			15.000
yjm-FS-I016	1 1/4	31.75	1 1/2	38.10	5	127.00	1/16	1.59			11.667
yjm-FS-I017	1 1/4	31.75	1 5/8	41.28	5	127.00		3.18			12.500
yjm-FS-I018	1 1/4	31.75	1 3/4	44.45	5	127.00	1/8	3.18			13.333
yjm-FS-I019	1 1/4	31.75	2	50.80	5	127.00	1/8	3.18			15.000
yjm-FS-I020	1 1/4	31.75	2 1/8	53.98	5	127.00	1/8	3.18			15.833
yjm-FS-I021	1 3/8	34.93	1 7/8	47.63	5 1/2	139.70	1/8	3.18			14.167
yjm-FS-I022	1 3/8	34.93	2	50.80	5 1/2	139.70	1/8	3.18			15.000

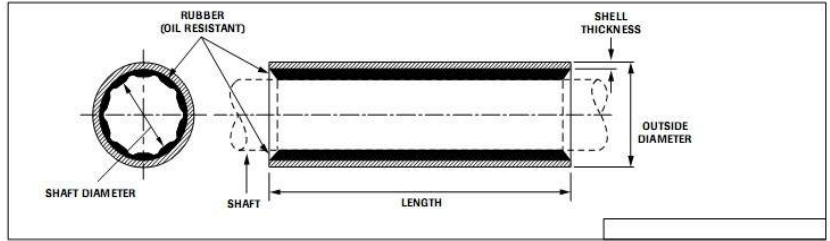

INCH SIZE SERIE NORMAL PRICE AS BELOW:

yjm-FS-I023	1 3/8	34.93	2 1/8	53.98	5 1/2	139.70	1/8	3.18			16.667
yjm-FS-I024	1 3/8	34.93	2 3/8	60.33	5 1/2	139.70	1/8	3.18			18.333
yjm-FS-I025	1 1/2	38.10	2	50.80	6	152.40	1/8	3.18			16.667
yjm-FS-I026	1 1/2	38.10		55.00		152.00		3.18			15.833
yjm-FS-I027	1 1/2	38.10		55.00	6"	152.40		3.18			16.667
yjm-FS-I028	1 1/2	38.10	2 1/4	57.15	6"	152.40		3.18			17.500
yjm-FS-I029	1 1/2	38.10	2 3/8	60.33	6	152.40	1/8	3.18			18.333
yjm-FS-I030	1 5/8	41.28	2 1/8	53.98	6 1/2	165.10	1/8	3.18			18.333
yjm-FS-I031	1 5/8	41.28	2 5/8	66.68	6 1/2	165.10	1/8	3.18			20.000
yjm-FS-I032	1 3/4	44.45	2 1/4	57.15	7	177.80		3.18			20.000
yjm-FS-I033	1 3/4	44.45	2 3/8	60.33	7	177.80	1/8	3.18			21.667
yjm-FS-I034	1 3/4	44.45	2 1/2	63.50	7	177.80		3.18			20.000
yjm-FS-I035	1 3/4	44.45	2 5/8	66.68	7	177.80	1/8	3.18			20.833
yjm-FS-I036	1 7/8	47.63	2 5/8	66.68	7 1/2	190.50	1/8	3.18			21.667
yjm-FS-I037	1 7/8	47.63	2 15/16	74.61	7 1/2	190.50	3/32	2.38			23.333
yjm-FS-I038	2	50.80	2 5/8	66.68	8	203.20	1/8	3.18			23.333
yjm-FS-I039	2	50.80	2 3/4	69.85	8	203.20	1/8	3.18			25.000
yjm-FS-I040	2	50.80	3	76.20	8	203.20	1/8	3.18			28.333
yjm-FS-I041	2 1/8	53.98	2 3/4	69.85	8 1/2	215.90		3.18			25.000
yjm-FS-I042	2 1/8	53.98	2 15/16	74.61	8 1/2	215.90	1/8	3.18			29.167
yjm-FS-I043	2 1/8	53.98	3	76.20	8 1/2	215.90		3.18			30.000
yjm-FS-I044	2 1/8	53.98	3 1/8	79.38	8 1/2	215.90	1/8	3.18			33.333
yjm-FS-I045	2 1/4	57.15	2 15/16	74.61	9	228.60	3/32	2.38			30.000
yjm-FS-I046	2 1/4	57.15	3	76.20	9	228.60	1/8	3.18			31.667
yjm-FS-I047	2 1/4	57.15	3 1/8	79.38	9	228.60	1/8	3.18			33.333
yjm-FS-I048	2 1/4	57.15	3 1/4	82.55	9	228.60		3.18			35.000
yjm-FS-I049	2 1/4	57.15	3 3/8	85.73	9	228.60	1/8	3.18			36.667
yjm-FS-I050	2 3/8	60.33	3	76.20	9 1/2	241.30		3.18			33.333
yjm-FS-I051	2 3/8	60.33	3 1/8	79.38	9 1/2	241.30		3.18			35.000
yjm-FS-I052	2 3/8	60.33	3 1/4	82.55	9 1/2	241.30		3.18			40.000
yjm-FS-I053	2 3/8	60.33	3 3/8	85.73	9 1/2	241.30	1/8	3.18			41.667
yjm-FS-I054	2 1/2	63.50	3	76.20	10	254.00		3.18			36.667
yjm-FS-I055	2 1/2	63.50	3 1/8	79.38	10	254.00	1/8	3.18			41.667
yjm-FS-I056	2 1/2	63.50	3 1/4	82.55	10	254.00		3.18			43.333
yjm-FS-I057	2 1/2	63.50	3 3/8	85.73	10	254.00	1/8	3.18			45.000
yjm-FS-I058	2 1/2	63.50	3 1/2	88.90	10	254.00	5/32	3.97			46.667
yjm-FS-I059	2 5/8	66.68	3 3/8	85.73	10 1/2	266.70	1/8	3.18			45.000
yjm-FS-I060	2 5/8	66.68	3 1/2	88.90	10 1/2	266.70		3.18			46.667
yjm-FS-I061	2 3/4	69.85	3 3/8	85.73	11	279.40	1/8	3.18			48.333
yjm-FS-I062	2 3/4	69.85	3 1/2	88.90	11	279.40	5/32	3.97			50.000
yjm-FS-I063	2 3/4	69.85	3 3/4	95.25	11	279.40	1/8	3.18			56.667
yjm-FS-I064	2 7/8	73.03	3 1/2	88.90	11 1/2	292.10		2.8			46.667

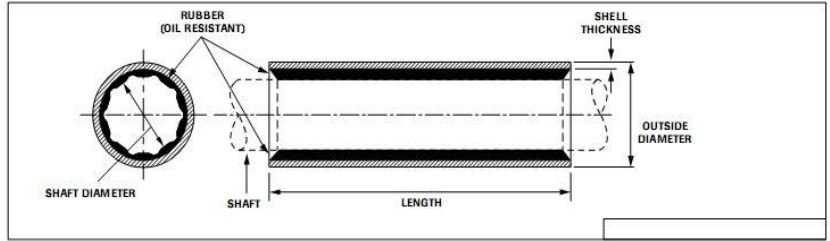

INCH SIZE SERIE NORMAL PRICE AS BELOW:

yjm-FS-I065	2 7/8	73.03	3 3/4	95.25	11 1/2	292.10	1/8	3.18			58.333
yjm-FS-I066	3	76.20	3 3/4	95.25	12	304.80	1/8	3.18			60.000
yjm-FS-I067	3	76.20	4	101.60	12	304.80	1/8	3.18			66.667
yjm-FS-I068	3	76.20		105.00	12	304.80		3.18			70.000
yjm-FS-I069	3	76.20	3 1/2	88.90	12	304.80		3.18			55.000
yjm-FS-I070	3	76.20	4 1/8	104.78	12	304.80		3.18			65.833
yjm-FS-I071	3 1/8	79.38	4 1/4	107.95	12 1/2	317.50	1/8	3.18			66.667
yjm-FS-I072	3 1/4	82.55	4	101.60	13	330.20	1/8	3.18			63.333
yjm-FS-I073	3 1/4	82.55	4 1/4	107.95	13	330.20	1/8	3.18			66.667
yjm-FS-I074	3 1/4	82.55	4 1/8	104.78	13	330.20		3.18			63.333
yjm-FS-I075	3 1/4	82.55	4 1/4	107.95	13	330.20		3.18			66.667
yjm-FS-I076	3 3/8	85.73	4 1/8	104.78	13 1/2	342.90		3.18			61.667
yjm-FS-I077	3 3/8	85.73	4 1/2	114.30	13 1/2	342.90	1/8	3.18			78.333
yjm-FS-I078	3 1/2	88.90	4 1/4	107.95	14	355.60	1/8	3.18			80.000
yjm-FS-I079	3 1/2	88.90	4 1/2	114.30	14	355.60	1/8	3.18			90.000
yjm-FS-I080	3 5/8	92.08	4 1/2	114.30	14 1/2	368.30	1/8	3.18			91.667
yjm-FS-I081	3 3/4	95.25	4 1/2	114.30	15	381.00	1/8	3.18			92.500
yjm-FS-I082	3 3/4	95.25	4 1/2	114.30	15	381.00		3.18			95.000
yjm-FS-I083	3 3/4	95.25	4 1/2	114.30	15	381.00		3.5			96.667
yjm-FS-I084	3 3/4	95.25	5	127.00	15	381.00	1/5	4.76			123.333
yjm-FS-I085	3 3/4	95.25	5 1/4	133.35	15	381.00	1/5	4.76			125.000
yjm-FS-I086	3 7/8	98.43	5 1/4	133.35	15 1/2	393.70	1/5	4.76			128.333
yjm-FS-I087	4	101.60	5	127.00	16	406.40	1/5	4.76			130.000
yjm-FS-I088	4	101.60	5 1/4	133.35	16	406.40	1/5	4.76			140.000
yjm-FS-I089	4 1/8	104.78	5 1/4	133.35	16 1/2	419.10	1/5	4.76			146.667
yjm-FS-I090	4 1/4	107.95	5 1/4	133.35	16 1/2	419.10		4.76			147.500
yjm-FS-I091	4 1/4	107.95	5 1/2	139.70	17	431.80	1/5	4.76			156.667
yjm-FS-I092	4 3/8	111.13	5 1/2	139.70	17	431.80		4.76			158.333
yjm-FS-I093	4 3/8	111.13	5 3/4	146.05	17 1/2	444.50	1/5	4.76			175.000
yjm-FS-I094	4 1/2	114.30	5 1/2	139.70	18	457.20	1/5	4.76			180.000
yjm-FS-I095	4 1/2	114.30	5 5/8	142.88	18	457.20		4.76			186.667
yjm-FS-I096	4 1/2	114.30	5 3/4	146.05	18	457.20	1/5	4.76			196.667
yjm-FS-I097	4 5/8	117.48	6 1/8	155.58	18 1/2	469.90	1/4	6.35			216.667
yjm-FS-I098	4 3/4	120.65	6 1/8	155.58	19	482.60	1/4	6.35			220.000
yjm-FS-I099	4 7/8	123.83	6 1/8	155.58	19	482.60	1/4	6.35			225.000
yjm-FS-I100	4 7/8	123.83	6 1/8	155.58	19 1/2	495.30	1/4	6.35			233.333
yjm-FS-I101	5	127.00	6 1/8	155.58	20	508.00	1/4	6.35			250.000
yjm-FS-I102	5	127.00	6 1/4	158.75	20	508.00	1/4	6.35			258.333
yjm-FS-I103	5	127.00	6 1/2	165.10	20	508.00	1/4	6.35			266.667
yjm-FS-I104	5 1/4	133.35	6 3/4	171.45	21	533.40	1/4	6.35			275.000
yjm-FS-I105	5 1/4	133.35	7	177.80	21	533.40	1/4	6.35			283.333

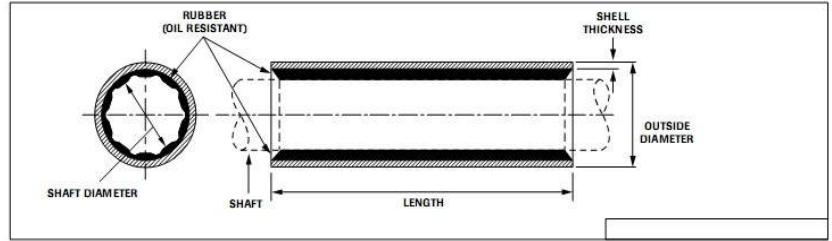

INCH SIZE SERIE NORMAL PRICE AS BELOW:

yjm-FS-I106	5 3/8	136.53	6 3/4	171.45	21 1/2	546.10	1/4	6.35			300.000
yjm-FS-I107	5 3/8	136.53	7	177.80	21 1/2	546.10	1/4	6.35			325.000
yjm-FS-I108	5 1/2	139.70	7	177.80	22	558.80	1/4	6.35			341.667
yjm-FS-I109	5 1/2	139.70	7 1/4	184.15	11"FL			9			0.000
yjm-FS-I110	5 1/2	139.70	7 1/4	184.15	22"FL			9			0.000
yjm-FS-I111	5 5/8	142.88	7	177.80	22 1/2	571.50	1/4	6.35			341.667
yjm-FS-I112	5 3/4	146.05	7	177.80	23	584.20	1/4	6.35			350.000
yjm-FS-I113	5 7/8	149.23	7 1/2	190.50	24	609.60	1/4	6.35			391.667
yjm-FS-I114	6	152.40	7 1/2	190.50	24	609.60	1/4	6.35			400.000
yjm-FS-I115	6	152.40	7 3/4	196.85	24 1/2	622.30	4/9	11.11			433.333
yjm-FS-I116	6 1/4	158.75	8	203.20	25	635.00	4/9	11.11			450.000
yjm-FS-I117	6 1/2	165.10	8 3/8	212.73	26	660.40	4/9	11.11			491.667
yjm-FS-I118	6 1/2	165.10	8 3/8	212.73	30	762.00	4/9	11.11			533.333

yjm Non-Metallic Sleeve Bearings

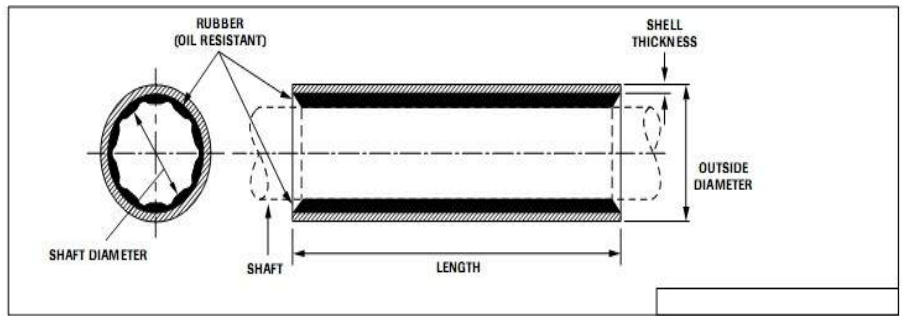
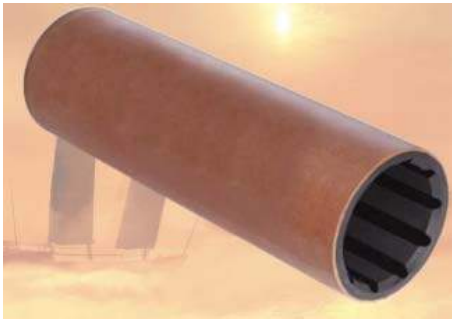

METRIC SIZE SERIES

Part Number	Shaft Diameter (mm)	Outside Diameter (mm)	Length (mm)	Shell Thickness (mm)	Weight		FOB Price USD
					lb.	kg.	
yjm-FS-M001	25	40	100	2.54	0.3	0.1	9.17
yjm-FS-M002	28	42	112	2.35	0.4	0.2	10.33
yjm-FS-M003	30	45	120	3.07	0.4	0.2	12.17
yjm-FS-M004	32	45	128	3.07	0.5	0.2	13.17
yjm-FS-M005	35	50	140	3.07	0.5	0.2	16.83
yjm-FS-M006	38	55	152	3.07	0.6	0.3	18.00
yjm-FS-M007	40	55	160	3.07	0.6	0.3	20.83
yjm-FS-M008	45	65	180	3.3	0.9	0.4	25.83
yjm-FS-M009	50	70	200	3.25	1.1	0.5	28.50
yjm-FS-M010	55	75	220	2.58	1.3	0.6	33.33
yjm-FS-M011	60	80	240	3.25	1.6	0.7	36.67
yjm-FS-M012	65	85	260	2.81	1.8	0.8	42.33
yjm-FS-M013	70	90	280	4.75	2	0.9	53.33
yjm-FS-M014	75	95	300	3.05	2.5	1.1	50.00
yjm-FS-M015	80	100	320	3.16	2.6	1.2	55.00
yjm-FS-M016	85	105	340	3.17	3	1.4	66.67
yjm-FS-M017	90	110	360	4.76	3.4	1.5	90.00
yjm-FS-M018	95	115	380	4.5	4	1.8	93.33
yjm-FS-M019	100	125	400	3.76	4.6	2.1	125.00
yjm-FS-M020	105	130	420	4.51	5.2	2.4	133.33
yjm-FS-M021	110	135	440	4.51	6	2.7	160.00
yjm-FS-M022	115	145	460	4.24	7.6	3.4	183.33
yjm-FS-M023	120	155	480	6.06	8.6	3.9	250.00
yjm-FS-M024	130	170	520	5.63	13	5.9	283.33

yjm Naval Brass Flanged Bearing

(STRUT OR AFT STERN TUBE)

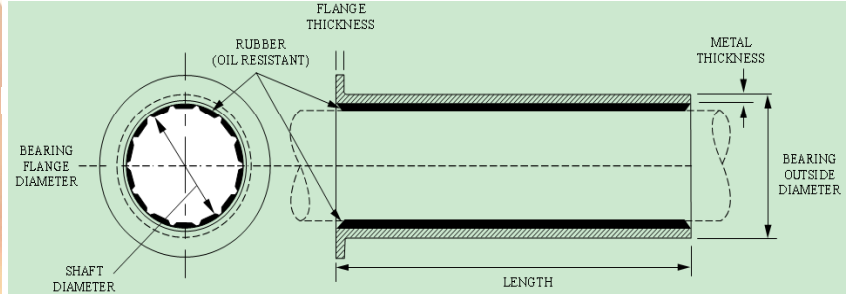
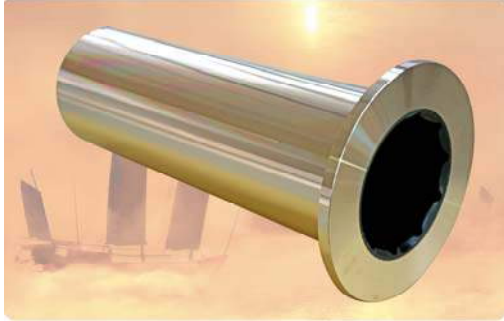

Part Number	Shaft	Outside	Lengt	Flange	Flange	Metal I.D.		Weight	
	inches	inches	inches	inches	inches	inches	mm	lb.	kg.
YJM AFT 001	2	3	8	5	3/8	2 5/8	66.68	7	3.2
YJM AFT 002	2 1/2	3 3/8	10	5 1/2	3/8	3 1/8	79.38	9	4.1
YJM AFT 003	3	4 1/4	6	6 3/4	1/2	3 3/4	95.25	20	9.1
YJM AFT 004	3	4 1/4	12	6 3/4	1/2	3 3/4	95.25	20	9.1
YJM AFT 005	3 1/4	4 1/2	6 1/2	7	1/2	4	101.6	22	10
YJM AFT 006	3 1/4	4 1/2	13	7	1/2	4	101.6	22	10
YJM AFT 007	3 1/2	4 3/4	12 1/2	6 3/4	1/2	4 1/4	107.95	21	9.5
YJM AFT 008	3 1/2	4 7/8	7	7 3/8	1/2	4 1/4	107.95	29	13.2
YJM AFT 009	3 1/2	4 7/8	14	7 3/8	1/2	4 1/4	107.95	29	13.2
YJM AFT 010	3 3/4	5 1/4	7 1/2	7 3/4	1/2	4 5/8	117.48	32	14.5
YJM AFT 011	3 3/4	5 1/4	15	7 3/4	1/2	4 5/8	117.48	32	14.5
YJM AFT 012	3 3/4	5 3/8	15	7 3/4	1/2	4 5/8	117.48	32	14.5
YJM AFT 013	3 3/4	5 3/4	7 1/2	7 3/4	1/2	4 5/8	117.48	32	14.5
YJM AFT 014	3 3/4	5 3/4	15	7 3/4	1/2	4 5/8	117.48	32	14.5
YJM AFT 015	4	5 1/2	8	8	1/2	4 7/8	123.83	36	16.3
YJM AFT 016	4	5 1/2	16	8	1/2	4 7/8	123.83	36	16.3
YJM AFT 017	4	5 7/8	16	8	1/2	4 7/8	123.83	36	16.3
YJM AFT 018	4 1/4	5 3/4	17	8 1/4	1/2	5 1/8	130.18	48	21.8
YJM AFT 019	4 3/8	6	22	8 7/8	1/2	5 3/8	136.53	64	29
YJM AFT 020	4 1/2	6	9	8 7/8	1/2	5 3/8	136.53	56	25.4
YJM AFT 021	4 1/2	6	18	8 7/8	1/2	5 3/8	136.53	56	25.4
YJM AFT 022	4 1/2	6 3/8	10	8 7/8	1/2	5 3/8	136.53	56	25.4
YJM AFT 023	4 1/2	6 3/8	18	8 7/8	1/2	5 3/8	136.53	56	25.4
YJM AFT 024	4 1/2	6 3/8	20	8 7/8	1/2	5 3/8	136.53	56	25.4
YJM AFT 025	4 3/4	6 1/4	19	9 1/8	1/2	5 3/8	136.53	62	28.1
YJM AFT 026	5	6 3/4	10	9 5/8	9/16	6	152.4	76	34.5
YJM AFT 027	5	6 3/4	20	9 5/8	9/16	6	152.4	76	34.5
YJM AFT 028	5	7	10	9 5/8	9/16	6	152.4	76	34.5
YJM AFT 029	5	7	20	9 5/8	9/16	6	152.4	76	34.5
YJM AFT 030	5 1/4	6 7/8	21	9 7/8	9/16	6 1/8	155.58	81	36.7
YJM AFT 031	5 1/2	7 1/4	11	10 1/4	9/16	6 1/2	165.1	86	39

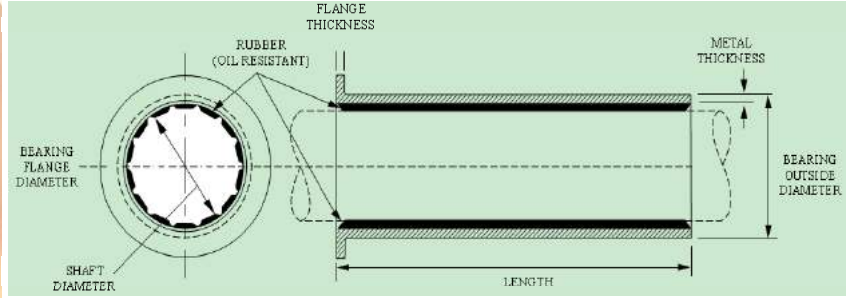
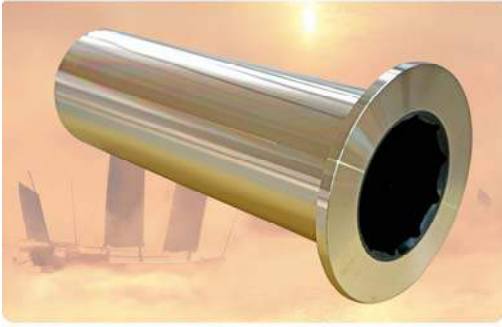

Part Number	Shaft	Outside	Lengt	Flange	Flange	Metal I.D.		Weight	
	inches	inches	inches	inches	inches	inches	mm	lb.	kg.
YJM AFT 032	5 1/2	7 1/4	22	10 1/4	9/16	6 1/2	165.1	86	39
YJM AFT 033	5 1/2	7 1/2	11	10 1/4	9/16	6 1/2	165.1	86	39
YJM AFT 034	5 1/2	7 1/2	22	10 1/4	9/16	6 1/2	165.1	86	39
YJM AFT 035	5 3/4	7 1/4	23	10 1/4	9/16	6 1/2	165.1	88	39.9
YJM AFT 036	6	7 3/4	15	12 1/4	9/16	6 1/2	165.1	75	34
YJM AFT 037	6	7 3/4	12	12 1/4	9/16	6 1/2	165.1	75	34
YJM AFT 038	6	7 3/4	24	11	9/16	7	177.8	101	45.8
YJM AFT 039	6 1/8	7 7/8	22	10 1/2	9/16	7	177.8	-	-
YJM AFT 040	6 1/4	8	22 1/2	10 5/8	9/16	7 1/8	180.98	97	44
YJM AFT 041	6 3/8	8 1/8	23	10 3/4	9/16	7 1/4	184.15	-	-
YJM AFT 042	6 1/2	8 3/8	13	11	9/16	7 3/8	187.33	113	51.3
YJM AFT 043	6 1/2	8 3/8	23 1/2	11	9/16	7 3/8	187.33	113	51.3
YJM AFT 044	6 1/2	8 3/8	26	11	9/16	7 3/8	187.33	113	51.3
YJM AFT 045	6 1/2	8 3/8	30	11	5/8	7 1/2	190.5	141	64
YJM AFT 046	6 5/8	8 1/2	15	13 1/2	5/8	7 1/2	190.5	100	45.4
YJM AFT 047	6 5/8	8 1/2	24	11 1/4	9/16	7 5/8	193.68	133	60.3
YJM AFT 048	6 5/8	8 5/8	24	11 1/4	9/16	7 5/8	193.68	130	59
YJM AFT 049	6 3/4	8 3/4	24	11 1/4	5/8	7 7/8	200.03	127	57.6
YJM AFT 050	6 3/4	8 3/4	24 1/2	11 3/8	9/16	7 7/8	200.03	135	61.2
YJM AFT 051	6 7/8	8 7/8	24 1/2	11 3/8	9/16	7 7/8	200.03	134	60.8
YJM AFT 052	6 7/8	8 7/8	25	11 1/2	9/16	8	203.2	-	-
YJM AFT 053	7	9	14	11 5/8	9/16	8 1/8	206.38	140	63.5
YJM AFT 054	7	9	25 1/2	11 5/8	9/16	8 1/8	206.38	140	63.5
YJM AFT 055	7	9	28	11 5/8	9/16	8 1/8	206.38	140	63.5
YJM AFT 056	7	9 5/8	14	11 5/8	9/16	8 1/8	206.38	140	63.5
YJM AFT 057	7	9 5/8	28	11 5/8	9/16	8 1/8	206.38	140	63.5
YJM AFT 058	7	9 1/8	25 1/2	11 5/8	9/16	8 1/8	206.38	154	69.9
YJM AFT 059	7 1/8	9 1/8	25 1/2	11 3/4	9/16	8 1/4	209.55	-	-
YJM AFT 060	7 1/4	9 1/4	26 1/2	11 7/8	9/16	8 3/8	212.73	150	68
YJM AFT 061	7 3/8	9 1/2	27	12 1/8	9/16	8 5/8	219.08	-	-
YJM AFT 062	7 1/2	9 5/8	17 1/2	14 1/2	1	8 3/4	222.25	129	58.5
YJM AFT 063	7 1/2	9 5/8	27 1/2	12 3/4	9/16	8 3/4	222.25	160	72.6
YJM AFT 064	7 5/8	9 3/4	28	12 3/8	9/16	8 3/4	222.25	-	-
YJM AFT 065	7 3/4	9 7/8	28 1/2	12 1/2	9/16	8 7/8	225.43	180	81.7
YJM AFT 066	7 7/8	10	29 1/2	12 5/8	9/16	9 1/8	231.78	-	-

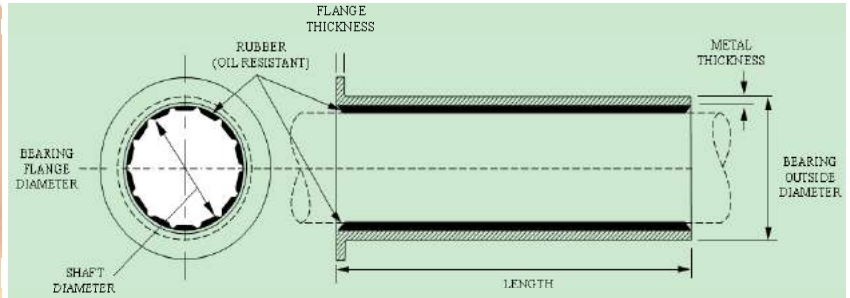
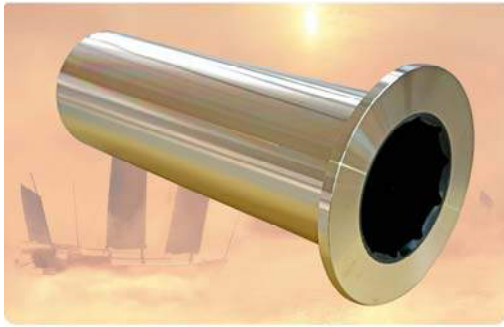

Part Number	Shaft	Outside	Lengt	Flange	Flange	Metal I.D.		Weight	
	inches	inches	inches	inches	inches	inches	mm	lb.	kg.
YJM AFT 067	8	10 1/4	16	13 1/4	5/8	9 1/2	241.3	166	75.3
YJM AFT 068	8	10 1/4	29 1/2	13 1/4	5/8	9 1/2	241.3	166	75.3
YJM AFT 069	8	10 1/4	32	13 1/4	5/8	9 1/2	241.3	166	75.3
YJM AFT 070	8	10 1/2	29 1/2	13 1/4	5/8	9 1/2	241.3	210	95.3
YJM AFT 071	8 1/8	10 3/8	30	13 3/8	5/8	9 3/8	238.13	-	-
YJM AFT 072	8 1/4	10 1/2	30 1/2	13 1/2	5/8	9 1/2	241.3	208	94.4
YJM AFT 073	8 3/8	10 5/8	31	13 5/8	5/8	9 5/8	241.3	-	-
YJM AFT 074	8 1/2	10 3/4	17	13 3/4	5/8	9 3/4	247.65	215	97.5
YJM AFT 075	8 1/2	10 3/4	31 1/2	13 3/4	5/8	9 3/4	247.65	215	97.5
YJM AFT 076	8 1/2	10 3/4	34	13 3/4	5/8	9 3/4	247.65	215	97.5
YJM AFT 077	8 5/8	10 7/8	32	13 7/8	5/8	9 7/8	250.83	-	-
YJM AFT 078	8 3/4	11	32 1/2	14	5/8	10	254	233	105.7
YJM AFT 079	8 7/8	11 1/8	33	14 1/8	3/4	10 1/8	257.18	-	-
YJM AFT 080	9	11 1/4	18	14 1/4	3/4	10 1/4	260.35	254	115.2
YJM AFT 081	9	11 1/4	33 1/2	14 1/4	3/4	10 1/4	260.35	254	115.2
YJM AFT 082	9	11 1/4	36	14 1/4	3/4	10 1/4	260.35	254	115.2
YJM AFT 083	9	11 1/2	33 3/8	15	3/4	10 1/4	260.35	301	136.5
YJM AFT 084	9 1/8	11 3/8	34	14 1/2	3/4	10 3/8	263.53	-	-
YJM AFT 085	9 1/8	11 1/2	34 1/2	16 3/8	5/8	10 3/8	263.53	284	128.8
YJM AFT 086	9 1/4	11 1/2	34 1/2	14 5/8	11/16	10 1/2	266.70	260	117.9
YJM AFT 087	9 3/8	11 5/8	35	14 3/4	3/4	10 5/8	269.88	-	-
YJM AFT 088	9 1/2	11 3/4	35 1/2	14 7/8	3/4	10 3/4	273.05	274	124.3
YJM AFT 089	9 5/8	11 7/8	36	15	3/4	10 7/8	276.23	-	-
YJM AFT 090	9 3/4	12 1/8	36 1/2	15 1/4	3/4	11	279.40	307	139.3
YJM AFT 091	9 7/8	12 1/4	37	15 3/8	3/4	11 1/8	282.58	-	-
YJM AFT 092	10	12 3/8	37 1/2	15 1/2	3/4	11 1/4	285.75	333	151.1
YJM AFT 093	10 1/8	12 1/2	38	15 5/8	3/4	11 1/4	285.75	-	-
YJM AFT 094	10 1/4	12 5/8	38 1/2	15 7/8	3/4	11 1/2	292.10	352	159.7
YJM AFT 095	10 3/8	12 3/4	39	16	3/4	11 5/8	295.28	-	-
YJM AFT 096	10 1/2	12 7/8	39 1/2	16 1/8	3/4	11 3/4	298.45	350	158.8
YJM AFT 097	10 5/8	13	40	16 1/4	3/4	11 7/8	301.63	-	-
YJM AFT 098	10 3/4	13 1/8	40 1/2	16 3/8	3/4	12	304.80	368	166.9
YJM AFT 099	10 7/8	13 1/4	41	17	3/4	12 1/8	307.98	-	-
YJM AFT 100	11	13 1/2	41 1/2	17 1/4	3/4	12 3/8	314.33	420	190.5
YJM AFT 101	11 1/8	13 5/8	42	17 3/8	3/4	12 1/2	317.50	-	-

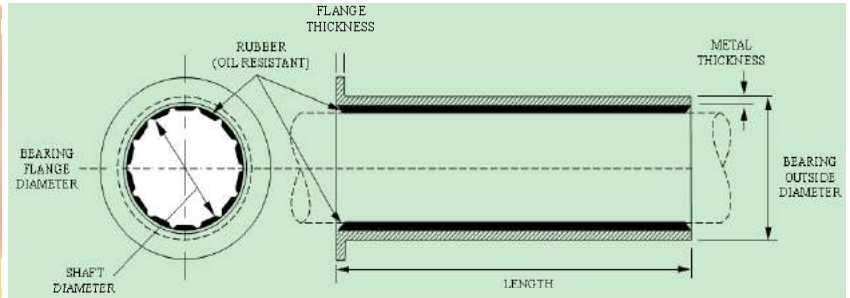
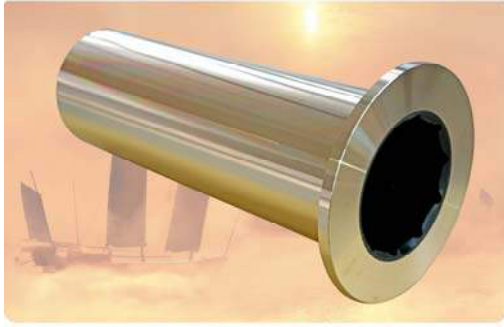

Part Number	Shaft	Outside	Lengt	Flange	Flange	Metal I.D.		Weight	
	inches	inches	inches	inches	inches	inches	mm	lb.	kg.
YJM AFT 102	11 1/4	13 3/4	42 1/2	17 1/2	3/4	12 5/8	320.68	432	196
YJM AFT 103	11 3/8	14	43	17 3/4	3/4	12 3/4	323.85	-	-
YJM AFT 104	11 1/2	14 1/8	43 1/2	17 7/8	3/4	12 7/8	327.03	482	218.6
YJM AFT 105	11 1/2	14 7/8	50 3/4	20 1/4	1 1/4	12 7/8	327.03	860	390.1
YJM AFT 106	11 5/8	14 1/4	44	18	3/4	13	330.20	-	-
YJM AFT 107	11 3/4	14 3/8	44 1/2	18 1/8	3/4	13 1/8	333.38	502	227.7
YJM AFT 108	11 7/8	14 1/2	45	18 1/4	3/4	13 1/4	336.55	-	-
YJM AFT 109	12	14 3/4	45 1/2	18 1/2	3/4	13 1/2	342.90	516	234.1
YJM AFT 110	12 1/8	14 7/8	46	18 5/8	3/4	13 5/8	346.08	-	-
YJM AFT 111	12 1/4	15	46 1/2	18 3/4	3/4	13 3/4	349.25	539	244.5
YJM AFT 112	12 3/8	15 1/8	47	18 7/8	3/4	13 7/8	352.43	-	-
YJM AFT 113	12 1/2	15 1/4	47 1/2	19	3/4	14	355.60	554	251.3
YJM AFT 114	12 5/8	15 3/8	48	19 1/8	3/4	14 1/8	358.78	582	264
YJM AFT 115	12 3/4	15 1/2	48 1/2	19 1/4	3/4	14 1/4	361.95	-	-
YJM AFT 116	12 7/8	15 5/8	49	19 3/8	3/4	14 3/8	365.13	-	-
YJM AFT 117	13	15 7/8	50	19 5/8	7/8	14 1/2	368.30	674	305.7
YJM AFT 118	13 1/8	16	50 1/2	19 3/4	7/8	14 5/8	371.48	710	322.1
YJM AFT 119	13 1/4	16 1/8	51	19 3/8	7/8	14 3/4	374.65	-	-
YJM AFT 120	13 3/8	16 1/4	51 1/2	20	7/8	14 7/8	377.83	696	315.7
YJM AFT 121	13 1/2	16 3/8	52	20 1/8	7/8	15	381.00	697	316.1
YJM AFT 122	13 5/8	16 1/2	52 1/2	20 1/4	7/8	15 1/8	384.18	-	-
YJM AFT 123	13 3/8	16 5/8	53	20 3/8	7/8	15 1/4	387.35	-	-
YJM AFT 124	13 7/8	16 3/4	53 1/2	20 1/2	7/8	15 3/8	390.53	-	-
YJM AFT 125	14	16 7/8	54	20 5/8	7/8	15 1/2	393.70	735	333.4
YJM AFT 126	14 1/8	17	54 1/2	20 3/4	7/8	15 5/8	396.88	-	-
YJM AFT 127	14 1/4	17 1/8	55	20 7/8	7/8	15 3/4	400.05	-	-
YJM AFT 128	14 3/8	17 1/4	55 1/2	21	7/8	15 7/8	403.23	842	381.9
YJM AFT 129	14 1/2	17 1/2	56	21 1/4	7/8	16	406.40	852	386.5
YJM AFT 130	14 5/8	17 5/8	56 1/2	21 3/8	7/8	16 1/8	409.58	-	-
YJM AFT 131	14 3/4	17 3/4	57	21 1/2	7/8	16 1/4	412.75	-	-
YJM AFT 132	14 7/8	17 7/8	57 1/2	21 5/8	7/8	16 3/8	415.93	-	-
YJM AFT 133	15	18	58	21 3/4	7/8	16 1/2	419.10	905	410.5

yjm FST Naval Brass Flanged Bearings

yjm FST Naval Brass Flanged Bearings are made of centrifugally cast naval brass and feature a heavy metal wall and integral flange. The specially formulated oil and chemical resistant NBR is securely bonded to the metal shell and is chemical and oil resistant.

PRECAUTION: When shrink fitting of the bearing is required, chilling must be achieved by gradual cooling to not more than minus 20°C using freezer or regular ice. (DO NOT DRY ICE) NOTE: Pounding or shocking the bearing while in the chilled state could cause the rubber to separate from the shell.

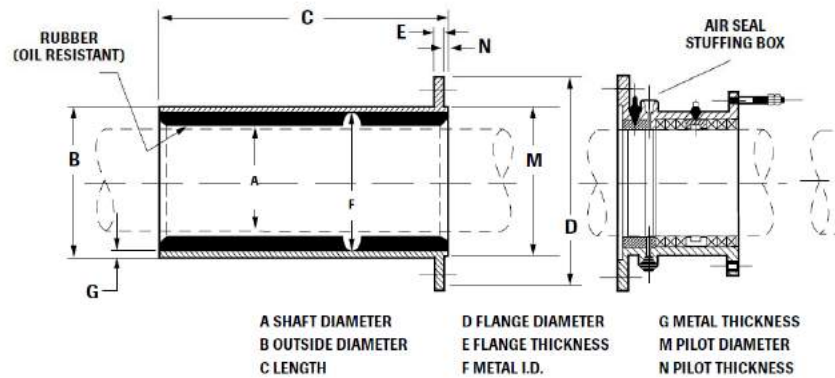
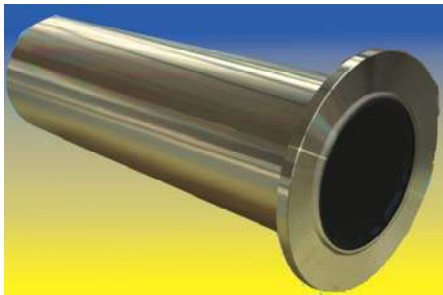

yjm FST Naval Brass Flanged Bearings (FORWARD STERN TUBE) inch

Part Number	Shaft Diameter (A) Dimensions inches	Outside Diameter (B) Dimensions inches	Length (C) inches	Flange Diameter (D) Dimensions inches	Flange Thickness (E) Dimensions inches	Metal I.D. (F) Dimensions inches	Metal Thickness (G) Dimensions inches	Pilot Diameter (M) Dimensions inches	Pilot Thickness (N) Dimensions inches
YJM FST001	2 1/2	3 3/8	10	6 1/4	3/8	3 1/8	1/8	4	3/16
YJM FST002	3	4 1/4	12	7 1/2	1/2	3 3/4	1/4	4 3/4	3/16
YJM FST003	3 1/4	4 1/2	13	7 1/2	1/2	4	1/4	4 3/4	3/16
YJM FST004	3 1/2	4 7/8	14	8 1/8	1/2	4 1/4	5/16	5 1/4	3/16
YJM FST005	3 3/4	5 1/4	15	8 1/8	1/2	4 5/8	5/16	5 1/4	3/16
YJM FST006	4	5 1/2	16	8 5/8	1/2	4 7/8	5/16	5 3/4	3/16
YJM FST007	4	5 1/2	8	8 5/8	1/2	4 7/8	5/16	5 3/4	3/16
YJM FST008	4 1/4	5 3/4	17	8 5/8	1/2	5 1/8	5/16	5 3/4	3/16
YJM FST009	4 1/2	6	18	9 3/8	1/2	5 3/8	5/16	6 1/2	3/16
YJM FST010	4 3/4	6 1/4	19	9 3/8	1/2	5 5/8	5/16	6 1/2	3/16
YJM FST011	5	6 3/4	20	10 1/8	9/16	6	3/8	7 1/4	3/16
YJM FST012	5 1/4	6 7/8	21	10 1/8	9/16	6 1/8	3/8	7 1/4	3/16
YJM FST013	5 1/2	7 1/4	22	10 5/8	9/16	6 1/2	3/8	7 3/4	3/16
YJM FST014	5 3/4	7 1/4	23	10 5/8	9/16	6 1/2	3/8	7 3/4	3/16
YJM FST015	6	7 3/4	15	11 3/8	9/16	7	3/8	8	3/8
YJM FST016	6 1/8	7 7/8	15	12 1/4	9/16	7 1/8	3/8	8	3/8
YJM FST017	6 1/4	7 7/8	15	11 3/8	9/16	7 1/8	3/8	8	3/8
YJM FST018	6 3/8	8 1/8	15	12 5/8	9/16	7 3/8	3/8	8 3/8	3/8
YJM FST019	6 1/2	8 3/8	15	13 1/2	5/8	7 1/2	7/16	8 5/8	3/8
YJM FST020	6 5/8	8 5/8	15	13 1/2	5/8	7 5/8	1/2	8 5/8	3/8
YJM FST021	6 5/8	8 1/2	15	13 1/2	5/8	7 5/8	7/16	8 5/8	3/8
YJM FST022	6 3/4	8 3/4	15	13 3/4	5/8	7 7/8	7/16	9	3/8

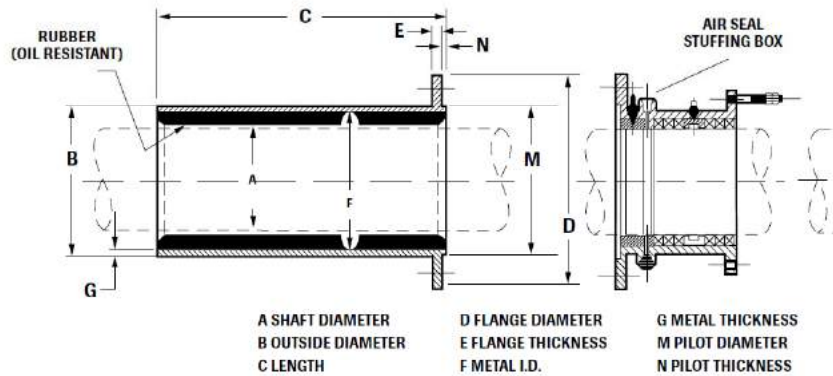
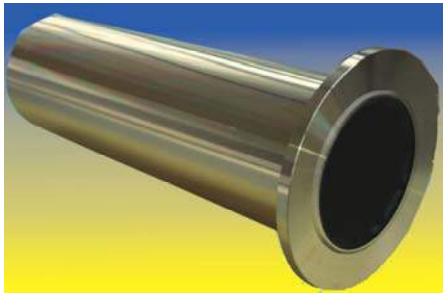

yjm FST Naval Brass Flanged Bearings (FORWARD STERN TUBE) inch

Part	Shaft Diameter (A) Dimensions	Outside Diameter (B) Dimensions	Length (C)	Flange Diameter (D) Dimensions	Flange Thickness (E) Dimensions	Metal I.D. (F) Dimensions	Metal Thickness (G) Dimensions	Pilot Diameter (M) Dimensions	Pilot Thickness (N) Dimensions
YJM FST023	6 7/8	8 7/8	15	13 3/4	5/8	8	7/16	9	3/8
YJM FST024	7	9	17 1/2	13 3/4	5/8	8 1/8	7/16	9	3/8
YJM FST025	7 1/8	9 1/8	17 1/2	14 1/8	5/8	8 1/4	7/16	9 5/8	3/8
YJM FST026	7 1/4	9 1/4	17 1/2	14 1/8	5/8	8 3/8	7/16	9 5/8	3/8
YJM FST027	7 3/8	9 1/2	17 1/2	14 1/8	5/8	8 5/8	7/16	9 5/8	3/8
YJM FST028	7 1/2	9 5/8	17 1/2	14 1/2	5/8	8 3/4	7/16	10	3/8
YJM FST029	7 5/8	9 3/4	17 1/2	14 1/2	5/8	8 7/8	7/16	10	3/8
YJM FST030	7 3/4	9 7/8	17 1/2	14 1/2	5/8	8 7/8	1/2	10	3/8
YJM FST031	7 7/8	10	17 1/2	14 7/8	5/8	9 1/8	7/16	10 3/8	3/8
YJM FST032	8	10 1/4	20	14 7/8	5/8	9 1/4	1/2	10 3/8	3/8
YJM FST033	8 1/8	10 3/8	20	14 7/8	5/8	9 3/8	1/2	10 3/8	3/8
YJM FST034	8 1/4	10 1/2	20	15 1/4	5/8	9 1/2	1/2	10 3/4	3/8
YJM FST035	8 3/8	10 5/8	20	15 1/4	5/8	9 5/8	1/2	10 3/4	3/8
YJM FST036	8 1/2	10 3/4	20	15 1/4	5/8	9 3/4	1/2	10 3/4	3/8
YJM FST037	8 5/8	10 7/8	20	15 5/8	3/4	9 7/8	1/2	11 1/8	3/8
YJM FST038	8 3/4	11	20	15 5/8	3/4	10	1/2	11 1/8	3/8
YJM FST039	8 7/8	11 1/8	20	15 5/8	3/4	10 1/8	1/2	11 1/8	3/8
YJM FST040	9	11 1/4	22 1/2	16	3/4	10 1/4	1/2	11 1/2	3/8
YJM FST041	9 1/8	11 3/8	22 1/2	16	3/4	10 3/8	1/2	11 1/2	3/8
YJM FST042	9 1/4	11 1/2	22 1/2	16	3/4	10 1/2	1/2	11 1/2	3/8
YJM FST043	9 3/8	11 5/8	22 1/2	16 3/8	3/4	10 5/8	1/2	11 7/8	3/8
YJM FST044	9 1/2	11 3/4	22 1/2	16 3/8	3/4	10 3/4	1/2	11 7/8	3/8
YJM FST045	9 5/8	11 7/8	22 1/2	16 3/8	3/4	10 7/8	1/2	11 7/8	3/8
YJM FST046	9 3/4	12 1/8	22 1/2	16 7/8	3/4	11	9/16	12 3/8	3/8
YJM FST047	9 7/8	12 1/4	22 1/2	16 7/8	3/4	11 1/8	9/16	12 3/8	3/8
YJM FST048	10	12 3/8	25	16 7/8	3/4	11 1/4	9/16	12 3/8	3/8
YJM FST049	10 1/8	12 1/2	25	17 7/8	3/4	11 3/8	9/16	12 3/4	3/8
YJM FST050	10 1/4	12 5/8	25	17 7/8	3/4	11 1/2	5/8	12 3/4	3/8
YJM FST051	10 3/8	12 3/4	25	17 7/8	3/4	11 5/8	9/16	12 3/4	3/8
YJM FST052	10 1/2	12 7/8	25	18 1/4	3/4	11 3/4	9/16	13 1/8	3/8
YJM FST053	10 5/8	13	25	18 1/4	3/4	11 7/8	9/16	13 1/8	3/8
YJM FST054	10 3/4	13 1/8	25	18 1/4	3/4	12	9/16	13 1/8	3/8
YJM FST055	10 7/8	13 1/4	25	18 5/8	3/4	12 1/8	9/16	13 1/2	3/8
YJM FST056	11	13 1/2	27 1/2	18 5/8	3/4	12 3/8	9/16	13 1/2	3/8
YJM FST057	11 1/8	13 5/8	27 1/2	18 5/8	3/4	12 1/2	9/16	13 1/2	3/8
YJM FST058	11 1/4	13 3/4	27 1/2	19	3/4	12 5/8	9/16	13 7/8	3/8
YJM FST059	11 3/8	14	27 1/2	19	3/4	12 3/4	5/8	13 7/8	3/8

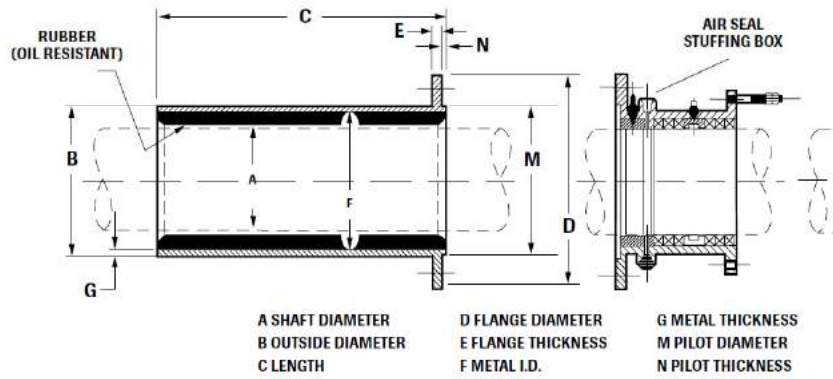

yjm FST Naval Brass Flanged Bearings (FORWARD STERN TUBE) inch

Part	Shaft Diameter (A) Dimensions	Outside Diameter (B) Dimensions	Length (C)	Flange Diameter (D) Dimensions	Flange Thickness (E) Dimensions	Metal I.D. (F) Dimensions	Metal Thickness (G) Dimensions	Pilot Diameter (M) Dimensions	Pilot Thickness (N) Dimensions
YJM FST060	11 1/2	14 1/8	27 1/2	19	3/4	12 7/8	5/8	13 7/8	3/8
YJM FST061	11 5/8	14 1/4	27 1/2	19 3/8	3/4	13	5/8	14 1/8	3/8
YJM FST062	11 3/4	14 3/8	27 1/2	19 3/8	3/4	13 1/8	5/8	14 1/8	3/8
YJM FST063	11 7/8	14 1/2	27 1/2	19 3/8	3/4	13 1/4	5/8	14 1/8	3/8
YJM FST064	12	14 3/4	30	19 3/4	3/4	13 1/2	5/8	14 1/2	3/8
YJM FST065	12 1/8	14 7/8	30	19 3/4	3/4	13 5/8	5/8	14 1/2	3/8
YJM FST066	12 1/4	15	30	19 3/4	3/4	13 3/4	5/8	14 1/2	3/8
YJM FST067	12 3/8	15 1/8	30	20 1/8	7/8	13 7/8	5/8	15 1/8	3/8
YJM FST068	12 1/2	15 1/4	30	20 1/8	7/8	14	5/8	15 1/8	3/8
YJM FST069	12 5/8	15 3/8	30	20 1/8	7/8	14 1/8	5/8	15 1/8	3/8
YJM FST070	12 3/4	15 1/2	30	20 1/2	7/8	14 1/4	5/8	15 1/2	3/8
YJM FST071	12 7/8	15 5/8	30	20 1/2	7/8	14 3/8	5/8	15 1/2	3/8
YJM FST072	13	15 7/8	32 1/2	20 1/2	7/8	14 1/2	11/16	15 1/2	3/8
YJM FST073	13 1/8	16	32 1/2	21	7/8	14 5/8	11/16	15 3/4	3/8
YJM FST074	13 1/4	16 1/8	32 1/2	21	7/8	14 3/4	11/16	15 3/4	3/8
YJM FST075	13 3/8	16 1/4	32 1/2	21	7/8	14 7/8	11/16	15 3/4	3/8
YJM FST076	13 1/2	16 3/8	32 1/2	21 3/8	7/8	15	11/16	16 1/4	3/8
YJM FST077	13 5/8	16 1/2	32 1/2	21 3/8	7/8	15 1/8	11/16	16 1/4	3/8
YJM FST078	13 3/4	16 5/8	32 1/2	21 3/8	7/8	15 1/4	11/16	16 1/4	3/8
YJM FST079	13 7/8	16 3/4	32 1/2	21 3/4	7/8	15 3/8	11/16	16 5/8	3/8
YJM FST080	14	16 7/8	35	21 3/4	7/8	15 1/2	11/16	16 5/8	3/8
YJM FST081	14 1/8	17	35	21 3/4	7/8	15 5/8	11/16	16 5/8	3/8
YJM FST082	14 1/4	17 1/8	35	22 1/8	7/8	15 3/4	11/16	17 1/4	3/8
YJM FST083	14 3/8	17 1/4	35	22 1/8	7/8	15 7/8	11/16	17 1/4	3/8
YJM FST084	14 1/2	17 1/2	35	22 1/8	7/8	16	3/4	17 1/4	3/8
YJM FST085	14 5/8	17 5/8	35	22 1/2	7/8	16 1/8	3/4	17 1/2	3/8
YJM FST086	14 3/4	17 3/4	35	22 1/2	7/8	16 1/4	3/4	17 1/2	3/8
YJM FST087	14 7/8	17 7/8	35	22 3/4	7/8	16 3/8	3/4	17 3/4	3/8
YJM FST088	15	18	35	22 3/4	7/8	16 1/2	3/4	17 3/4	3/8

Four cylindrical marine bearings are arranged in a cluster, with two in the foreground and two slightly behind them. They have a metallic, brushed finish. The background is a blue gradient with white wavy lines and several translucent blue spheres of varying sizes.

MARINE BEARINGS

JULU COUNTY HONGWEI SEALING & ELECTRIC PARTS CO., LTD

ADD: Yangguan Road, Julu Economic Development area ,Julu County ,Hebei Province ,China.

Tel: 0086 319 3791518 Fax: 0086 319 3791520

Mobile Phone: +86-018631989599 +86-018632900333

MSN: yjm1649@hotmail.com Skype:yjmwilliam

Web: www.hwmf.com

E-mail: yjmwilliam@hwmf.com yjmmay@hwmf.com yjm4391171@yahoo.com